

Power MOSFET

| PRODUCT SUMMARY | | |
|---------------------------|------------------------|------|
| V_{DS} (V) | 50 | |
| $R_{DS(on)}$ (Ω) | $V_{GS} = 10\text{ V}$ | 0.10 |
| Q_g (Max.) (nC) | 17 | |
| Q_{gs} (nC) | 9.0 | |
| Q_{gd} (nC) | 3.0 | |
| Configuration | Single | |

FEATURES

- Extremely Low $R_{DS(on)}$
- Compact Plastic Package
- Fast Switching
- Low Drive Current
- Ease of Paralleling
- Excellent Temperature Stability
- Parts Per Million Quality
- Compliant to RoHS Directive 2002/95/EC



Available
RoHS*
 COMPLIANT

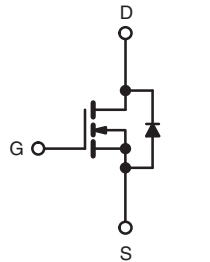
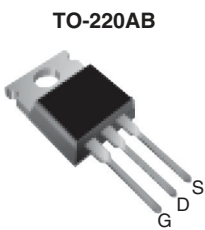

N-Channel MOSFET

DESCRIPTION

The technology has expanded its product base to serve the low voltage, very low $R_{DS(on)}$ MOSFET transistor requirements. Vishay's highly efficient geometry and unique processing have been combined to create the lowest on resistance per device performance. In addition to this feature all have documented reliability and parts per million quality!

The transistor also offer all of the well established advantages of MOSFETs such as voltage control, very fast switching, ease of paralleling, and temperature stability of the electrical parameters.

They are well suited for applications such as switching power supplies, motor controls, inverters, choppers, audio amplifiers, high energy pulse circuits, and in systems that are operated from low voltage batteries, such as automotive, portable equipment, etc.

| ORDERING INFORMATION | |
|----------------------|------------|
| Package | TO-220AB |
| Lead (Pb)-free | IRFZ20PbF |
| | SiHFZ20-E3 |
| SnPb | IRFZ20 |
| | SiHFZ20 |



| ABSOLUTE MAXIMUM RATINGS | | | | |
|--|----------------------------------|-----------------------------------|---------------------------------|---------------------|
| PARAMETER | SYMBOL | | LIMIT | UNIT |
| Drain-Source Voltage ^a | V_{DS} | | 50 | V |
| Gate-Source Voltage ^a | V_{GS} | | ± 20 | |
| Continuous Drain Current | V_{GS} at 10 V | $T_C = 25\text{ }^\circ\text{C}$ | 15 | A |
| | | $T_C = 100\text{ }^\circ\text{C}$ | 10 | |
| Pulsed Drain Current ^b | I_{DM} | | 60 | |
| Single Pulse Avalanche Energy ^c | E_{AS} | | 5 | mJ |
| Linear Derating Factor (see fig. 16) | | | 0.32 | W/ $^\circ\text{C}$ |
| Maximum Power Dissipation (see fig. 16) | $T_C = 25\text{ }^\circ\text{C}$ | | 40 | W |
| Operating Junction and Storage Temperature Range | T_J, T_{stg} | | - 55 to + 150 | $^\circ\text{C}$ |
| Soldering Recommendations (Peak Temperature) | for 10 s | | 300 (0.063" (1.6 mm) from case) | |

Notes

- $T_J = 25\text{ }^\circ\text{C}$ to $150\text{ }^\circ\text{C}$
- Repetitive rating: Pulse width limited by max. junction temperature. See transient temperature impedance curve (see fig. 11).
- Starting $T_J = 25\text{ }^\circ\text{C}$, $L = 0.07\text{ mH}$, $R_g = 25\text{ }^\circ\Omega$, $I_{AS} = 12\text{ A}$

* Pb containing terminations are not RoHS compliant, exemptions may apply

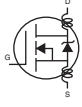
| THERMAL RESISTANCE RATINGS | | | | |
|--|------------|------|------|------|
| PARAMETER | SYMBOL | TYP. | MAX. | UNIT |
| Typical Socket Mount, Junction-to-Ambient | R_{thJA} | - | 80 | °C/W |
| Case-to-Sink, Mounting Surface Flat, Smooth, and Greased | R_{thCS} | 1.0 | - | |
| Junction-to-Case | R_{thJC} | - | 3.12 | |

| ELECTRICAL CHARACTERISTICS ($T_J = 25\text{ }^\circ\text{C}$, unless otherwise noted) | | | | | | |
|---|--------------|---|------|-------|-----------|---------------|
| PARAMETER | SYMBOL | TEST CONDITIONS | MIN. | TYP. | MAX. | UNIT |
| Static | | | | | | |
| Drain-Source Breakdown Voltage | V_{DS} | $V_{GS} = 0\text{ V}, I_D = 250\text{ }\mu\text{A}$ | 50 | - | - | V |
| Gate-Source Threshold Voltage | $V_{GS(th)}$ | $V_{DS} = V_{GS}, I_D = 250\text{ }\mu\text{A}$ | 2.0 | - | 4.0 | V |
| Gate-Source Leakage | I_{GSS} | $V_{GS} = \pm 20\text{ V}$ | - | - | ± 500 | nA |
| Zero Gate Voltage Drain Current | I_{DSS} | $V_{DS} > \text{Max. Rating}, V_{GS} = 0\text{ V}$ | - | - | 250 | μA |
| | | $V_{DS} = \text{Max. Rating} \times 0.8, V_{GS} = 0\text{ V}, T_C = 125\text{ }^\circ\text{C}$ | - | - | 1000 | |
| On-State Drain Current | $I_{D(on)}$ | $V_{GS} = 10\text{ V}, V_{DS} > I_{D(on)} \times R_{DS(on)} \text{ max.}$ | - | - | 15 | A |
| Drain-Source On-State Resistance ^b | $R_{DS(on)}$ | $V_{GS} = 10\text{ V}, I_D = 10\text{ A}$ | - | 0.080 | 0.10 | Ω |
| Forward Transconductance ^b | g_{fs} | $V_{DS} > I_{D(on)} \times R_{DS(on)} \text{ max.}, I_D = 9.0\text{ A}$ | 5.0 | 6.0 | - | S |
| Dynamic | | | | | | |
| Input Capacitance | C_{iss} | $V_{GS} = 0\text{ V}, V_{DS} = 25\text{ V}, f = 1.0\text{ MHz}, \text{ see fig. 11}$ | - | 560 | 860 | pF |
| Output Capacitance | C_{oss} | | - | 250 | 350 | |
| Reverse Transfer Capacitance | C_{rss} | | - | 60 | 100 | |
| Total Gate Charge | Q_g | $V_{GS} = 10\text{ V}, I_D = 20\text{ A}, V_{DS} = 0.8 \text{ max. rating, see fig. 18 for test circuit (Gate charge is essentially independent of operating temperature)}$ | - | 12 | 17 | nC |
| Gate-Source Charge | Q_{gs} | | - | 9.0 | - | |
| Gate-Drain Charge | Q_{gd} | | - | 3.0 | - | |
| Turn-On Delay Time | $t_{d(on)}$ | $V_{DD} = 25\text{ V}, I_D = 9.0\text{ A}, Z_0 = 50\text{ }\Omega, \text{ see fig. 5}^b$ | - | 15 | 30 | ns |
| Rise Time | t_r | | - | 45 | 90 | |
| Turn-Off Delay Time | $t_{d(off)}$ | | - | 20 | 40 | |
| Fall Time | t_f | | - | 15 | 30 | |
| Internal Drain Inductance | L_D | Modified MOSFET symbol showing the internal device inductances  | - | 3.5 | - | nH |
| Internal Source Inductance | L_S | | - | 4.5 | - | |
| Drain-Source Body Diode Characteristics | | | | | | |
| Continuous Source-Drain Diode Current | I_S | MOSFET symbol showing the integral reverse p - n junction rectifier  | - | - | 15 | A |
| Pulsed Diode Forward Current ^a | I_{SM} | | - | - | 60 | |
| Body Diode Voltage ^b | V_{SD} | $T_C = 25\text{ }^\circ\text{C}, I_S = 15\text{ A}, V_{GS} = 0\text{ V}$ | - | - | 1.5 | V |
| Body Diode Reverse Recovery Time | t_{rr} | $T_J = 150\text{ }^\circ\text{C}, I_F = 15\text{ A}, dI_F/dt = 100\text{ A}/\mu\text{s}$ | - | 100 | - | ns |
| Body Diode Reverse Recovery Charge | Q_{rr} | | - | 0.4 | - | μC |
| Forward Turn-On Time | t_{on} | Intrinsic turn-on time is negligible (turn-on is dominated by L_S and L_D) | | | | |

Notes

- Repetitive rating: Pulse width limited by max. junction temperature. See transient temperature impedance curve (see fig. 5).
- Pulse test: Pulse width $\leq 300\text{ }\mu\text{s}$; duty cycle $\leq 2\%$.

TYPICAL CHARACTERISTICS (25 °C, unless otherwise noted)

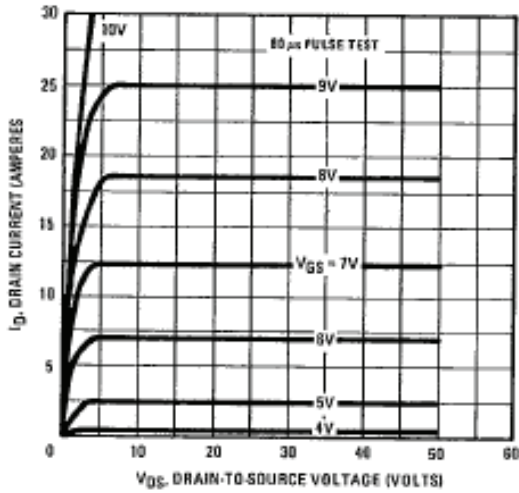

Fig. 1 - Typical Output Characteristics

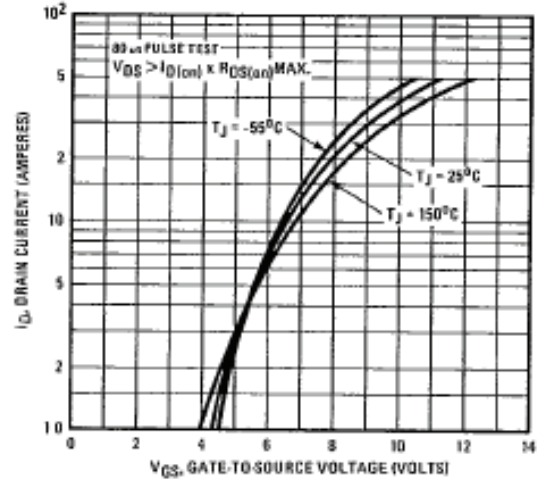

Fig. 3 - Typical Transfer Characteristics

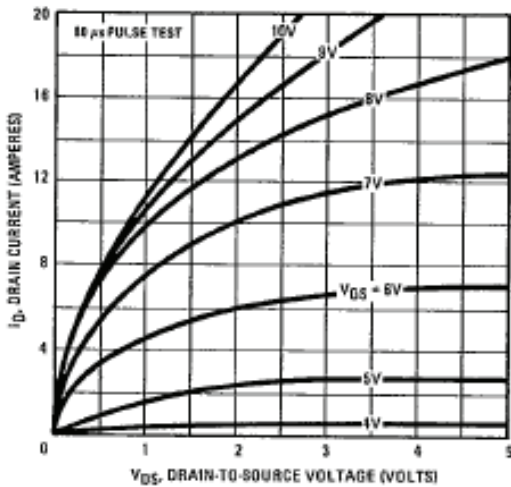

Fig. 2 - Typical Saturation Characteristics

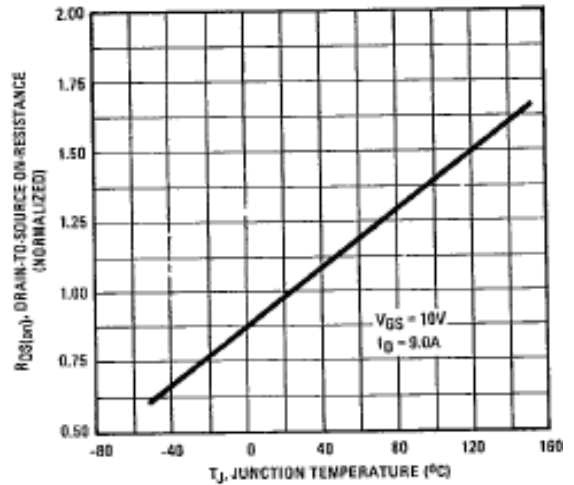

Fig. 4 - Normalized On-Resistance vs. Temperature

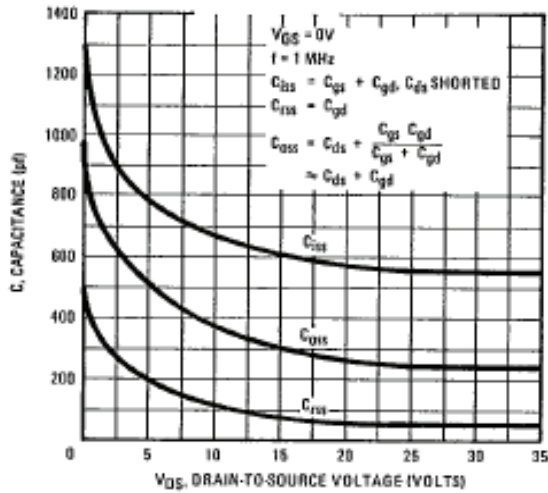

Fig. 5 - Typical Capacitance vs. Drain-to-Source Voltage

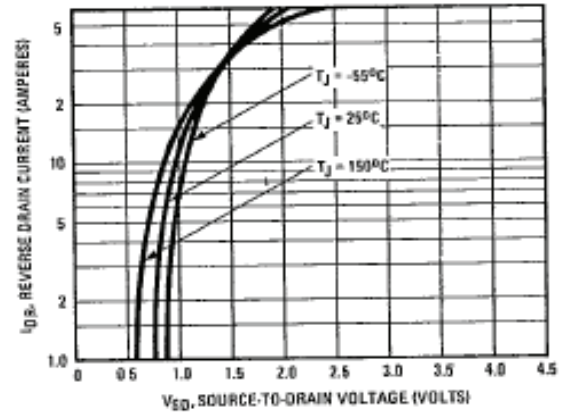

Fig. 7 - Typical Source-Drain Diode Forward Voltage

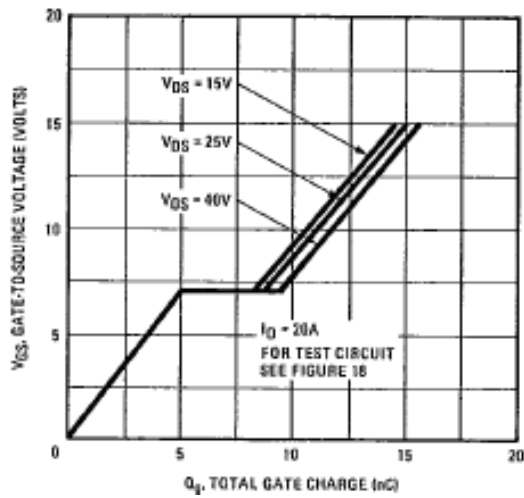

Fig. 6 - Typical Gate Charge vs. Gate-to-Source Voltage

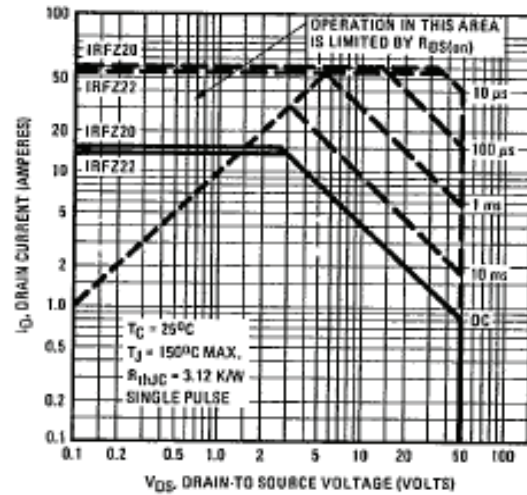

Fig. 8 - Maximum Safe Operating Area

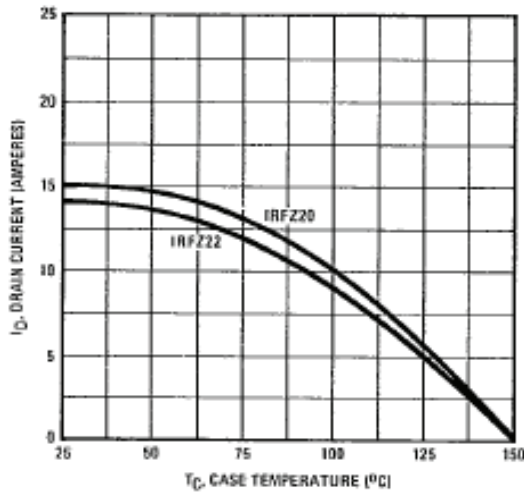

Fig. 9 - Maximum Drain Current vs. Case Temperature

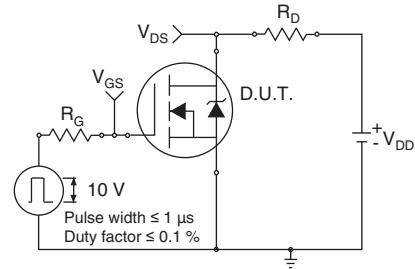

Fig. 10a - Switching Time Test Circuit

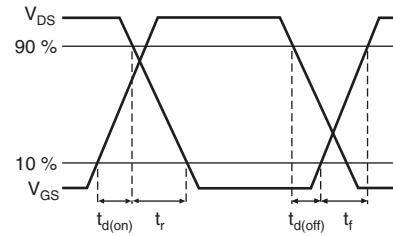

Fig. 10b - Switching Time Waveforms

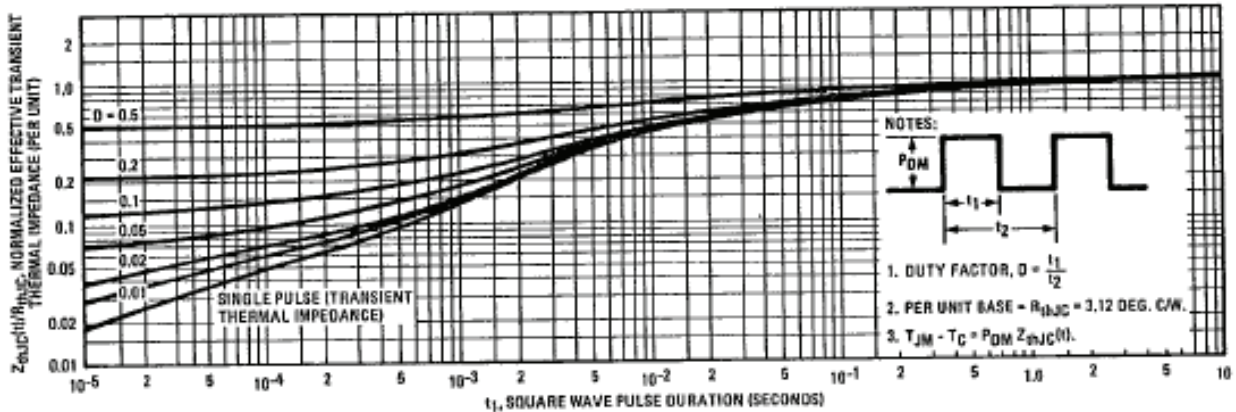

Fig. 11 - Maximum Effective Transient Thermal Impedance, Junction-to-Case vs. Pulse Duration

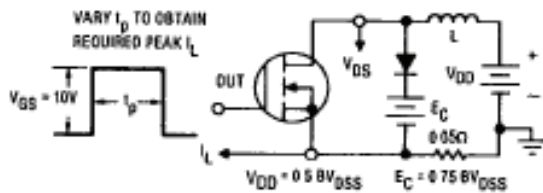

Fig. 12a - Clamped Inductive Test Circuit

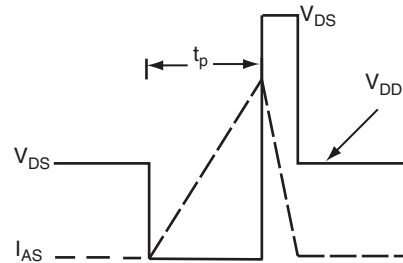

Fig. 12b - Unclamped Inductive Waveforms

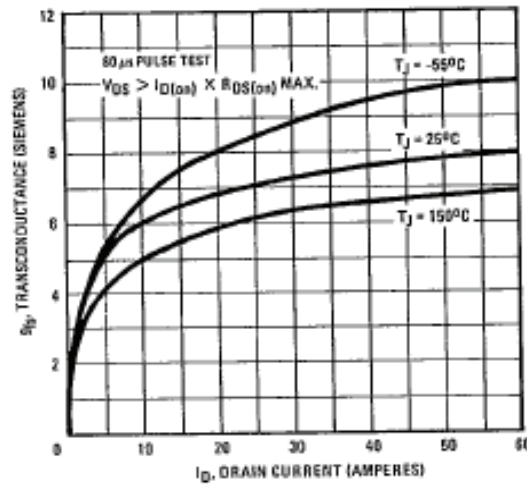

Fig. 13 - Typical Transconductance vs. Drain Current

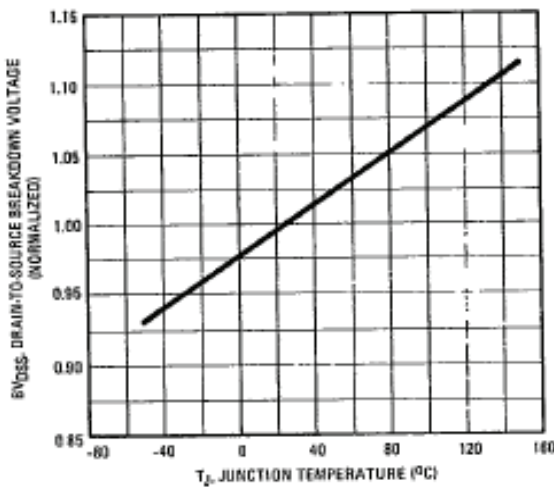

Fig. 14 - Breakdown Voltage vs. Temperature

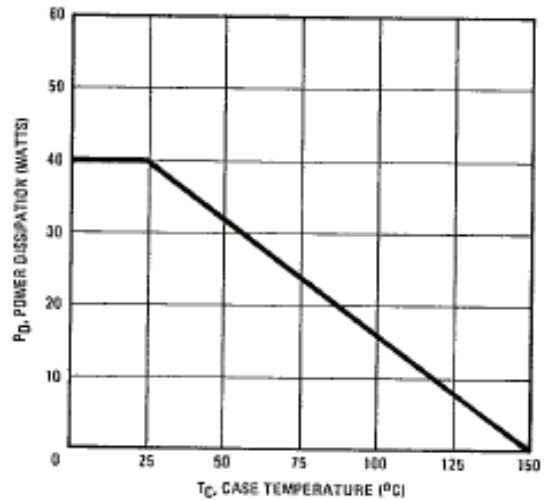

Fig. 16 - Power vs. Temperature Derating Curve

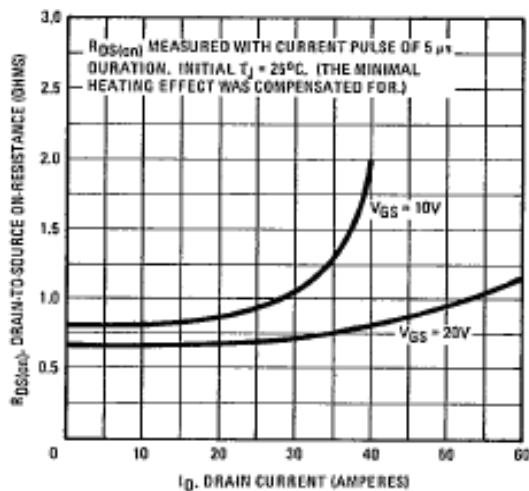

Fig. 15 - Typical On-Resistance vs. Drain Current

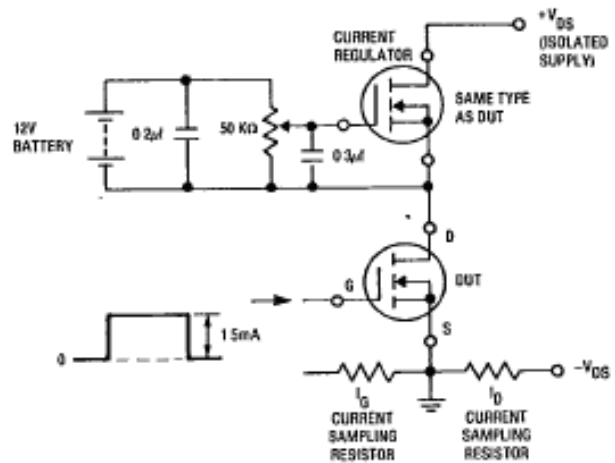
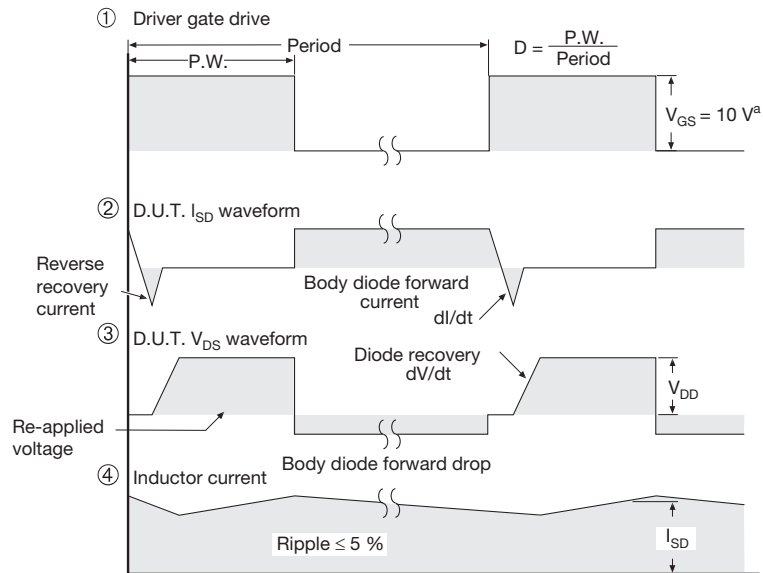
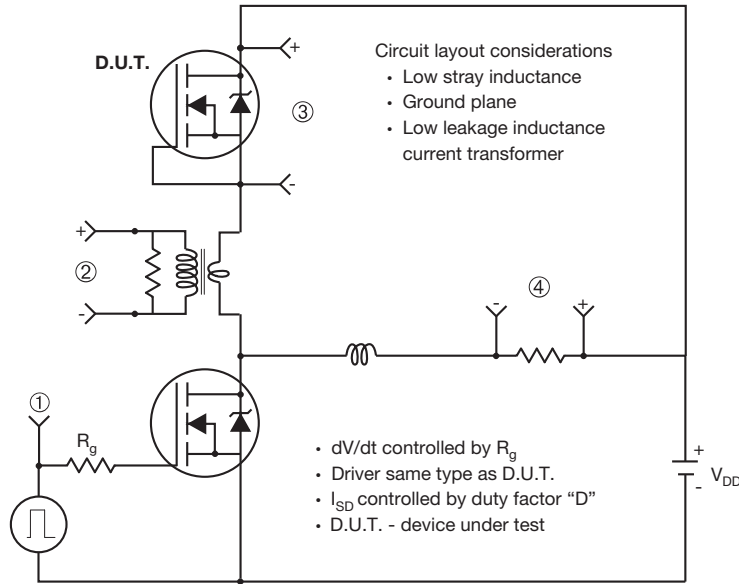

Fig. 17 - Gate Charge Test Circuit

Peak Diode Recovery dV/dt Test Circuit



Note
a. $V_{GS} = 5\text{ V}$ for logic level devices

Fig. 14 - For N-Channel

Vishay Siliconix maintains worldwide manufacturing capability. Products may be manufactured at one of several qualified locations. Reliability data for Silicon Technology and Package Reliability represent a composite of all qualified locations. For related documents such as package/tape drawings, part marking, and reliability data, see <http://www.vishay.com/ppg?91340>.



TO-220-1

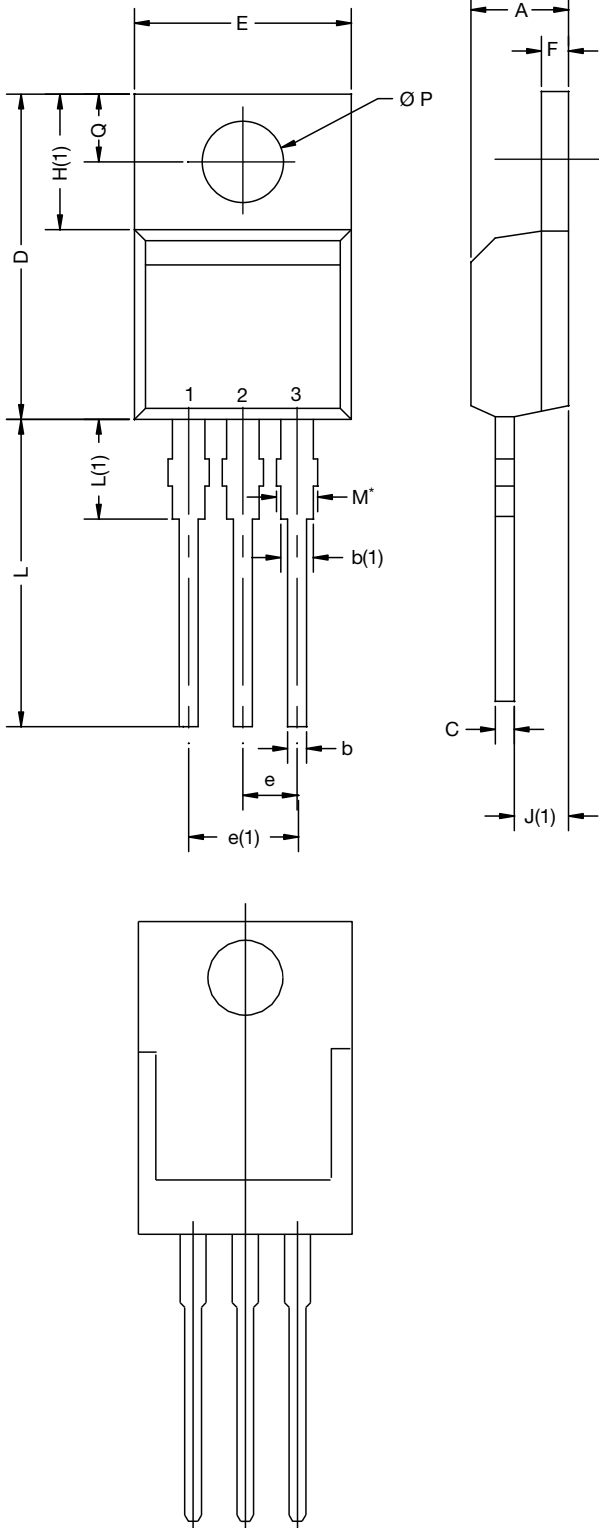

| DIM. | MILLIMETERS | | INCHES | |
|-----------------|-------------|-------|--------|-------|
| | MIN. | MAX. | MIN. | MAX. |
| A | 4.14 | 4.70 | 0.163 | 0.185 |
| b | 0.69 | 1.02 | 0.027 | 0.040 |
| b(1) | 1.14 | 1.78 | 0.045 | 0.070 |
| c | 0.36 | 0.61 | 0.014 | 0.024 |
| D | 14.32 | 15.86 | 0.564 | 0.624 |
| E | 9.96 | 10.52 | 0.392 | 0.414 |
| e | 2.41 | 2.67 | 0.095 | 0.105 |
| e(1) | 4.88 | 5.28 | 0.192 | 0.208 |
| F | 0.51 | 1.40 | 0.020 | 0.055 |
| H(1) | 6.10 | 6.70 | 0.240 | 0.264 |
| J(1) | 2.41 | 2.92 | 0.095 | 0.115 |
| L | 13.36 | 14.40 | 0.526 | 0.567 |
| L(1) | 3.33 | 4.05 | 0.131 | 0.159 |
| $\varnothing P$ | 3.53 | 3.94 | 0.139 | 0.155 |
| Q | 2.54 | 3.00 | 0.100 | 0.118 |

ECN: X15-0339-Rev. B, 02-Nov-15
DWG: 6031

Note

- M^* = 0.052 inches to 0.064 inches (dimension including protrusion), heatsink hole for HVM



Disclaimer

ALL PRODUCT, PRODUCT SPECIFICATIONS AND DATA ARE SUBJECT TO CHANGE WITHOUT NOTICE TO IMPROVE RELIABILITY, FUNCTION OR DESIGN OR OTHERWISE.

Vishay Intertechnology, Inc., its affiliates, agents, and employees, and all persons acting on its or their behalf (collectively, "Vishay"), disclaim any and all liability for any errors, inaccuracies or incompleteness contained in any datasheet or in any other disclosure relating to any product.

Vishay makes no warranty, representation or guarantee regarding the suitability of the products for any particular purpose or the continuing production of any product. To the maximum extent permitted by applicable law, Vishay disclaims (i) any and all liability arising out of the application or use of any product, (ii) any and all liability, including without limitation special, consequential or incidental damages, and (iii) any and all implied warranties, including warranties of fitness for particular purpose, non-infringement and merchantability.

Statements regarding the suitability of products for certain types of applications are based on Vishay's knowledge of typical requirements that are often placed on Vishay products in generic applications. Such statements are not binding statements about the suitability of products for a particular application. It is the customer's responsibility to validate that a particular product with the properties described in the product specification is suitable for use in a particular application. Parameters provided in datasheets and/or specifications may vary in different applications and performance may vary over time. All operating parameters, including typical parameters, must be validated for each customer application by the customer's technical experts. Product specifications do not expand or otherwise modify Vishay's terms and conditions of purchase, including but not limited to the warranty expressed therein.

Except as expressly indicated in writing, Vishay products are not designed for use in medical, life-saving, or life-sustaining applications or for any other application in which the failure of the Vishay product could result in personal injury or death. Customers using or selling Vishay products not expressly indicated for use in such applications do so at their own risk. Please contact authorized Vishay personnel to obtain written terms and conditions regarding products designed for such applications.

No license, express or implied, by estoppel or otherwise, to any intellectual property rights is granted by this document or by any conduct of Vishay. Product names and markings noted herein may be trademarks of their respective owners.

Material Category Policy

Vishay Intertechnology, Inc. hereby certifies that all its products that are identified as RoHS-Compliant fulfill the definitions and restrictions defined under Directive 2011/65/EU of The European Parliament and of the Council of June 8, 2011 on the restriction of the use of certain hazardous substances in electrical and electronic equipment (EEE) - recast, unless otherwise specified as non-compliant.

Please note that some Vishay documentation may still make reference to RoHS Directive 2002/95/EC. We confirm that all the products identified as being compliant to Directive 2002/95/EC conform to Directive 2011/65/EU.

Vishay Intertechnology, Inc. hereby certifies that all its products that are identified as Halogen-Free follow Halogen-Free requirements as per JEDEC JS709A standards. Please note that some Vishay documentation may still make reference to the IEC 61249-2-21 definition. We confirm that all the products identified as being compliant to IEC 61249-2-21 conform to JEDEC JS709A standards.