

# SN75LBC786

## QUADRUPLE RS-423-B DRIVER/RECEIVER WITH LOOPBACK

SLLS184 – NOVEMBER 1994

- Four Independent Drivers and Receivers
- Loopback Mode Functionally Self Tests Drivers and Receivers Without Disconnection From Line
- Driver Slew Rate Controlled by a Single Resistor
- Internal Thermal-Overload Protection
- RS-423-B Inputs and Outputs Designed to Withstand  $\pm 25$  V
- ESD Protection Exceeds 2000 V Per MIL-STD-883C Method 3015
- LinBiCMOS™ Process Technology

DW PACKAGE  
(TOP VIEW)

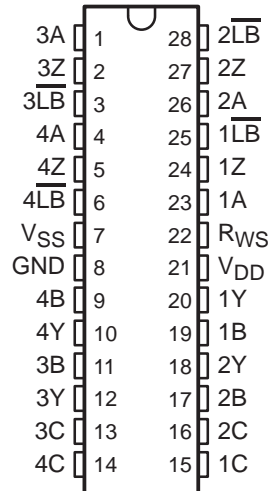

### description

The SN75LBC786 is a monolithic quadruple RS-423-B driver and receiver with integrated-loopback function. The operation of the SN75LBC786 is closely based on that of the SN75186. In normal operation, the device performs as four independent RS-423-B driver/receiver pairs designed to interface data-terminal equipment (DTE) with data circuit-terminating equipment (DCE). In loopback mode, the signal from each driver output is fed back via special circuitry into its associated receiver input, removing the need to locally disconnect cables and install a loopback connector. The receiver output signal is the same as the driver input signal.

The SN75LBC786 is characterized for operation over the temperature range of 0°C to 70°C.

FUNCTION TABLE

LOOPBACK LB	INPUTS			OUTPUTS	
	A	B	C	Z	Y
H	L	L	H	H	H
H	H	L	H	H	L
H	L	H	L	L	H
H	H	H	L	L	L
H	L	L	L	?	H
H	H	L	L	?	L
H	L	H	H	?	H
H	H	H	H	?	L
L	L	X	X	L	L
L	H	X	X	H	L

H = high level, L = low level, X = irrelevant, ? = indeterminate



Please be aware that an important notice concerning availability, standard warranty, and use in critical applications of Texas Instruments semiconductor products and disclaimers thereto appears at the end of this data sheet.

LinBiCMOS is a trademark of Texas Instruments Incorporated.

PRODUCTION DATA information is current as of publication date. Products conform to specifications per the terms of Texas Instruments standard warranty. Production processing does not necessarily include testing of all parameters.



POST OFFICE BOX 655303 • DALLAS, TEXAS 75265

Copyright © 1994, Texas Instruments Incorporated

# SN75LBC786 QUADRUPLE RS-423-B DRIVER/RECEIVER WITH LOOPBACK

SLLS184 – NOVEMBER 1994

## logic diagram (positive logic) (each transceiver)

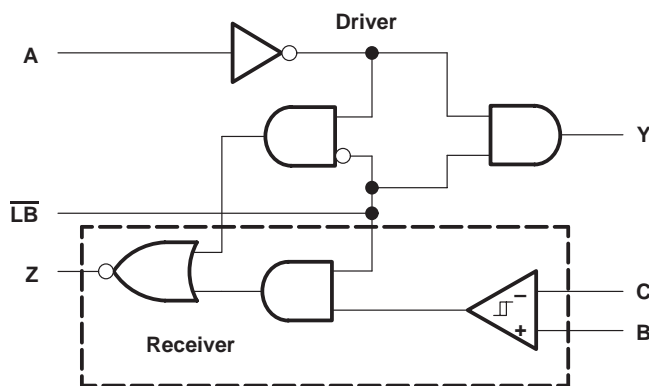

## absolute maximum ratings over operating free-air temperature range (unless otherwise noted)†

Positive supply voltage, $V_{DD}$ (see Note 1)	14 V
Negative supply voltage, $V_{SS}$	-14 V
Receiver input voltage range	-30 V to 30 V
Driver input voltage range	-0.5 V to 5.75 V
Loopback input voltage range	-0.5 V to 5.75 V
Driver output voltage range (supplies at 0 V)	-30 V to 30 V
Driver output voltage range (supplies at $\pm 12$ V)	-25 V to 25 V
Continuous power dissipation at (or below) $T_A = 70^\circ\text{C}$	800 mW
Operating free-air temperature range, $T_A$	$0^\circ\text{C}$ to $70^\circ\text{C}$
Storage temperature range, $T_{stg}$	$-65^\circ\text{C}$ to $150^\circ\text{C}$
Case temperature for 10 seconds	$260^\circ\text{C}$

† Stresses beyond those listed under "absolute maximum ratings" may cause permanent damage to the device. These are stress ratings only, and functional operation of the device at these or any other conditions beyond those indicated under "recommended operating conditions" is not implied. Exposure to absolute-maximum-rated conditions for extended periods may affect device reliability.

NOTE 1: All voltages are with respect to network ground terminal.

## recommended operating conditions

		MIN	NOM	MAX	UNIT
Supply voltage, $V_{DD}$		10.8	12	13.2	V
Supply voltage, $V_{SS}$		-10.8	-12	-13.2	V
High-level input voltage, $V_{IH}$	Driver and loopback	2			V
Low-level input voltage, $V_{IL}$	Driver and loopback			0.8	V
High-level output current, $I_{OH}$	Receiver			-4	mA
Low-level output current, $I_{OL}$	Receiver			4	mA
Slew rate control resistor, $R_{WS}$		20	82	820	k $\Omega$
Operating free-air temperature, $T_A$		0		70	$^\circ\text{C}$

# SN75LBC786

## QUADRUPLE RS-423-B DRIVER/RECEIVER WITH LOOPBACK

SLLS184 – NOVEMBER 1994

### DRIVER SECTION

**electrical characteristics over recommended ranges of supply voltage and operating free-air temperature (unless otherwise noted)**

PARAMETER		TEST CONDITIONS	MIN	TYP	MAX	UNIT
V <sub>OH</sub>	High-level output voltage	Open circuit or R <sub>I</sub> = 450 Ω	4	5.5	6	V
V <sub>OL</sub>	Low-level output voltage	Open circuit or R <sub>I</sub> = 450 Ω	-6	-5.5	-4	V
I <sub>IH</sub>	High-level input current	V <sub>I</sub> = 2.4 V – 5.5 V			100	μA
I <sub>IL</sub>	Low-level input current	V <sub>I</sub> = 0 V – 0.8 V	-100			μA
I <sub>IKG</sub>	Output leakage current	V <sub>DD</sub> = V <sub>SS</sub> = 0 V, V <sub>O</sub> = ±6 V	-100		100	μA
I <sub>OS(H)</sub>	High-level short-circuit output current	V <sub>I</sub> = high, V <sub>O</sub> = 0 V	15		45	mA
I <sub>OS(L)</sub>	Low-level short-circuit output current	V <sub>I</sub> = low, V <sub>O</sub> = 0 V	-45		-15	mA
I <sub>DD</sub>	Supply current (loopback off)	No load, $\overline{\text{LB}}$ at 2 V		10	12	mA
		R <sub>I</sub> = 450 Ω, $\overline{\text{LB}}$ at 2 V		60	70	
I <sub>DD(LB)</sub>	Supply current with loopback on	No load, $\overline{\text{LB}}$ at 0.8 V		13	16	mA
I <sub>SS</sub>	Supply current (loopback off)	No load, $\overline{\text{LB}}$ at 2 V		-10	-12	mA
		R <sub>I</sub> = 450 Ω, $\overline{\text{LB}}$ at 2 V		-60	-70	
I <sub>DD</sub>	Supply current with loopback on	No load, $\overline{\text{LB}}$ at 0.8 V		-13	-16	mA
<b>LOOPBACK MODE</b>						
Output voltage (input either high or low)		R <sub>I</sub> = > 450 Ω, V <sub>LB</sub> = low	-6	-5.5	-4	V

**switching characteristics over recommended ranges of supply voltage and operating free-air temperature (unless otherwise noted)**

PARAMETER		TEST CONDITIONS	MIN	TYP	MAX	UNIT	
t <sub>TLH</sub>	Transition time, low-to-high level output (see Figure 1)	R <sub>I</sub> = 450 Ω, V <sub>WS</sub> = 5 V, C <sub>L</sub> = 50 pF,	R <sub>WS</sub> = 0 kΩ		1.5	μs	
			R <sub>WS</sub> = 20 kΩ	1.5	2.1		2.7
			R <sub>WS</sub> = 82 kΩ	5	8		11
			R <sub>WS</sub> = 820 kΩ		80		
t <sub>THL</sub>	Transition time, high-to-low level output (see Figure 1)		R <sub>WS</sub> = 0 kΩ		1.5	μs	
			R <sub>WS</sub> = 20 kΩ	1.5	2.1		2.7
			R <sub>WS</sub> = 82 kΩ	5	8		11
SR	Output slew rate		R <sub>WS</sub> = 820 kΩ		80		V/μs
t <sub>sk</sub>	Output skew,  t <sub>PHL</sub> - t <sub>PLH</sub>   (see Figure 4)	R <sub>WS</sub> = 20 kΩ		15		V/μs	
		R <sub>WS</sub> = 82 kΩ		1		μs	



# SN75LBC786

## QUADRUPLE RS-423-B DRIVER/RECEIVER WITH LOOPBACK

SLLS184 – NOVEMBER 1994

### RECEIVER SECTION

**electrical characteristics over recommended ranges of supply voltage and operating free-air temperature (unless otherwise noted)**

PARAMETER		TEST CONDITIONS	MIN	TYP	MAX	UNIT
V <sub>IT</sub>	Receiver input threshold voltage (see Figure 5)	V <sub>IT</sub> = (V <sub>I+</sub> - V <sub>I-</sub> )	-200		200	mV
		V <sub>IT</sub> = (V <sub>I+</sub> - V <sub>I-</sub> ) with 500-Ω series resistor	-400		400	
I <sub>I</sub>	Input current	Other input to GND	V <sub>I</sub> = 10 V	1.3	3.25	mA
			V <sub>I</sub> = -10 V	-3.25	-1.3	
V <sub>hys</sub>	Hysteresis voltage		20	40	150	mV
V <sub>OH</sub>	High-level output voltage (see Note 2)	I <sub>O</sub> = -20 μA	3.5		5	V
		I <sub>O</sub> = -4 mA	2.4		5	
V <sub>OL</sub>	Low-level output voltage	I <sub>O</sub> = 20 μA to 4 mA			0.4	V
I <sub>OS</sub>	RX short circuit current				50	mA
V <sub>ID</sub>	Differential input voltage	Receiver inputs open circuit	1.6	2.1	2.6	V
V <sub>ofs</sub>	Fail safe output voltage	See Note 3	3.5			V

- NOTES: 2. Device has an internal RX supply regulator. Maximum RX logic output voltage under no load is thus defined by an internal voltage value. This is nominally set to 4.5 V with a tolerance of ±5%.  
 3. One input at ground, other input open circuit, I<sub>O</sub> = -20 μA, or both open circuit.

**switching characteristics over recommended ranges of supply voltage and operating free-air temperature (unless otherwise noted)**

PARAMETER		TEST CONDITIONS	MIN	NOM	MAX	UNIT
t <sub>PLH</sub>	Propagation delay time, low-to-high (see Figure 2)	C <sub>L</sub> = 50 pF		0.15	1	μs
t <sub>PHL</sub>	Propagation delay time, high-to-low (see Figure 2)					
t <sub>THL</sub>	Transition time, high-to-low (see Figure 3)			20	200	ns
t <sub>TLH</sub>	Transition time, low-to-high (see Figure 3)					



**PARAMETER MEASUREMENT INFORMATION**

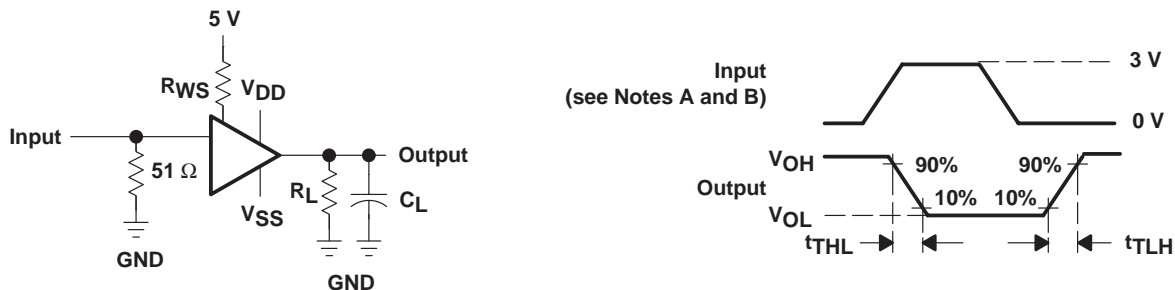

- NOTES: A.  $C_L$  includes probe and jig capacitance.  
 B. The input pulse is supplied by a generator having the following characteristics:  $t_r \leq 10$  nS,  $t_f < 10$  nS,  $Z_o = 50 \Omega$ ,  $PRR \geq 5$  kHz, duty cycle = 50%,  $V_{max} = 3$  V,  $V_{min} = 0$  V.

**Figure 1. Driver Transition Times**

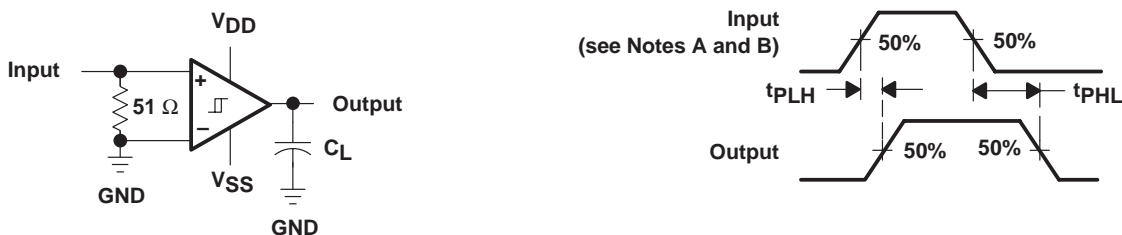

- NOTES: A.  $C_L$  includes probe and jig capacitance.  
 B. The input pulse is supplied by a generator having the following characteristics:  $t_r \leq 10$  nS,  $t_f < 10$  nS,  $Z_o = 50 \Omega$ ,  $PRR \geq 5$  kHz, duty cycle = 50%,  $V_{max} = 0.5$  V,  $V_{min} = -0.5$  V.

**Figure 2. Receiver Propagation Delay Times**

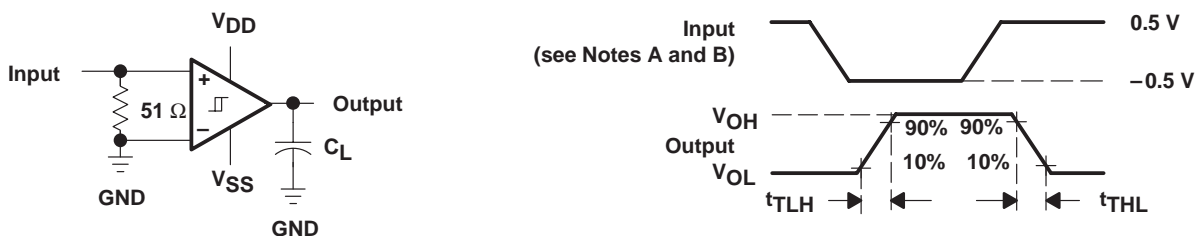

- NOTES: A.  $C_L$  includes probe and jig capacitance.  
 B. The input pulse is supplied by a generator having the following characteristics:  $t_r \leq 10$  nS,  $t_f < 10$  nS,  $Z_o = 50 \Omega$ ,  $PRR \geq 5$  kHz, duty cycle = 50%,  $V_{max} = 0.5$  V,  $V_{min} = -0.5$  V.

**Figure 3. Receiver Transition Times**

# SN75LBC786 QUADRUPLE RS-423-B DRIVER/RECEIVER WITH LOOPBACK

SLLS184 – NOVEMBER 1994

## PARAMETER MEASUREMENT INFORMATION

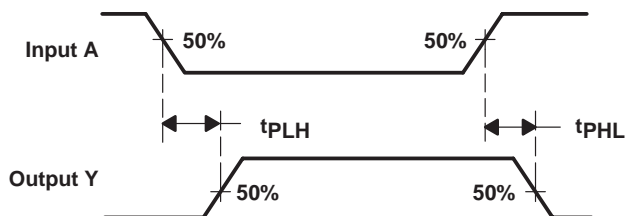

Figure 4. Skew Definition Times

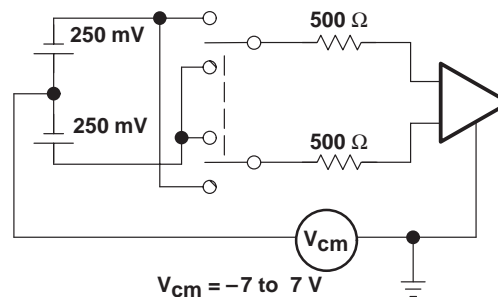

Figure 5. Input Balance Test

## PRINCIPLES OF OPERATION

In normal operation, the SN75LBC786 functions as four independent drivers and receivers. The loopback mode is disabled by maintaining a high logic level on the  $\overline{\text{LB}}$  input. The receivers consist of differential comparators with hysteresis and resistive attenuation on the inputs. The resistive attenuation improves the input common-mode range and also provides additional protection from ESD and over-voltage stress. The differential and common-mode input impedance are sufficiently high to meet RS-423-B. The balance of the receiver input voltage current characteristics and bias voltage is such that the receiver remains in the intended binary state when a differential voltage of 500 mV is applied to the inputs through 500  $\Omega$  across the entire common-mode range (see Figure 5).

The drivers meet all RS-423-B specifications. In normal operation, the drivers have built-in current limits and thermal overload protection. Slew-rate controlling circuitry is included into the design that is adjusted to suit the application by means of an external resistor. The slew-rate controlling circuitry also has a default mode. If  $R_{\text{WS}}$  is shorted to 5 V externally, the transition time defaults to approximately 1.5  $\mu\text{s}$ . The receiver is compatible to the RS-232 with the use of external input resistors to meet the RS-232 input-resistance specification of 3 k $\Omega$  to 7 k $\Omega$ .

Taking an individual  $\overline{\text{LB}}$  input low activates the loopback mode in the corresponding driver/receiver pair. This causes the output from that driver to be fed back to the input of its receiver through dedicated internal-loopback circuitry. Data from the receiver output can then be compared, by a communication system, with the data transmitted to the driver to determine if the functional operation of the driver and receiver together is correct.

In the loopback mode, external data at the input of the receiver is ignored and the driver does not transmit data onto the line. Extraneous data is prevented internally from being sent by the driver in the loopback mode by clamping its output to a level below the maximum interface voltage, -5 V, or the EIA-423-B marking state. Below this marking level, a reduced 1.5-V output amplitude is used at the driver output. This signal is detected by an on-chip loopback comparator and fed to the input stage of the receiver to complete the loop.

Line faults external to the SN75LBC786 are detected in addition to device failures. These line faults include short circuits to ground and to external supply voltages. The loopback mode should be entered only when the driver output is low, that is, the marking condition. It is recommended that loopback not be entered when the driver output is in a high state as this may cause a low-level, nondamaging oscillation at the driver output.

## IMPORTANT NOTICE

Texas Instruments and its subsidiaries (TI) reserve the right to make changes to their products or to discontinue any product or service without notice, and advise customers to obtain the latest version of relevant information to verify, before placing orders, that information being relied on is current and complete. All products are sold subject to the terms and conditions of sale supplied at the time of order acknowledgement, including those pertaining to warranty, patent infringement, and limitation of liability.

TI warrants performance of its semiconductor products to the specifications applicable at the time of sale in accordance with TI's standard warranty. Testing and other quality control techniques are utilized to the extent TI deems necessary to support this warranty. Specific testing of all parameters of each device is not necessarily performed, except those mandated by government requirements.

CERTAIN APPLICATIONS USING SEMICONDUCTOR PRODUCTS MAY INVOLVE POTENTIAL RISKS OF DEATH, PERSONAL INJURY, OR SEVERE PROPERTY OR ENVIRONMENTAL DAMAGE ("CRITICAL APPLICATIONS"). TI SEMICONDUCTOR PRODUCTS ARE NOT DESIGNED, AUTHORIZED, OR WARRANTED TO BE SUITABLE FOR USE IN LIFE-SUPPORT DEVICES OR SYSTEMS OR OTHER CRITICAL APPLICATIONS. INCLUSION OF TI PRODUCTS IN SUCH APPLICATIONS IS UNDERSTOOD TO BE FULLY AT THE CUSTOMER'S RISK.

In order to minimize risks associated with the customer's applications, adequate design and operating safeguards must be provided by the customer to minimize inherent or procedural hazards.

TI assumes no liability for applications assistance or customer product design. TI does not warrant or represent that any license, either express or implied, is granted under any patent right, copyright, mask work right, or other intellectual property right of TI covering or relating to any combination, machine, or process in which such semiconductor products or services might be or are used. TI's publication of information regarding any third party's products or services does not constitute TI's approval, warranty or endorsement thereof.