

# REFERENCE DESIGN

## IRDCiP1203-A

International Rectifier • 233 Kansas Street, El Segundo, CA 90245 USA

### IRDCiP1203-A: 400kHz, 15A, Synchronous Buck Converter Using iP1203

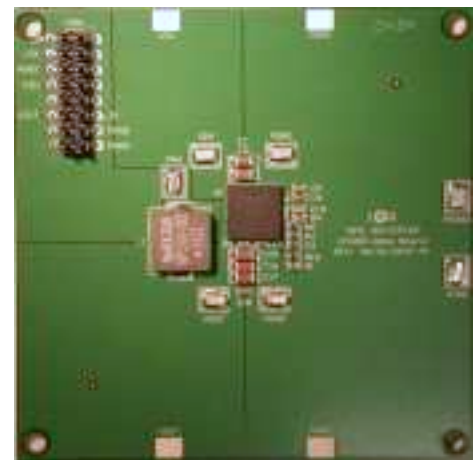


#### Overview

This reference design is capable of delivering a continuous current of 15A (with heatsink) or 12A (without heatsink) at an ambient temperature of 45°C and airflow of 300LFM. Figures 1–20 provide performance graphs, thermal images, and waveforms. Figures 21–33 and Table 1 are provided to engineers as design references for implementing an iP1203 solution.

The components installed on this demoboard were selected based on operating at an input voltage of 12V (+/-10%) and a switching frequency of 400kHz (+/-15%). Major changes from these set points may require optimizing the control loop and/or adjusting the values of input/output filters in order to meet the user's specific application requirements. Refer to the iP1203 datasheet User Design Guidelines section for more information.

Note: The 16-pin connector (CON1) is used only for production test purposes and should not be used for evaluation of this demoboard.



(Photo shown without heatsink)

#### Demoboard Quick Start Guide

##### **Initial Settings:**

VOUT is set to 1.8V, but can be adjusted from 1.0V to 3.3V by changing the values of R3 and R7 according to the following formula:

$$R3 = R7 = (15k * 0.8) / (VOUT - 0.8)$$

The switching frequency is set to 400kHz, but can be adjusted by changing the value of R10. The graph in Figure 22 shows the relationship between R10 and the switching frequency.

##### **Power Up Procedure:**

1. Apply input voltage across VIN and PGND.
2. Apply load across VOUT pads and PGND pads.
3. Adjust load to desired level. See recommendations below.

#### IRDCiP1203-A Recommended Operating Conditions

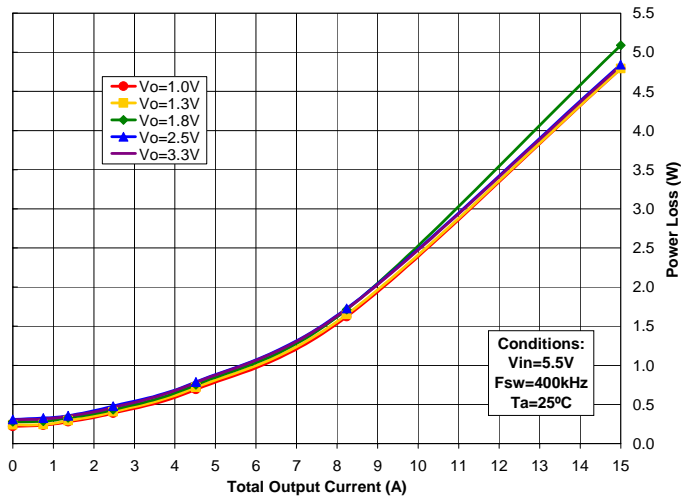
(refer to the iP1203 datasheet for maximum operating conditions)

Input voltage: 5.5V – 13.2V

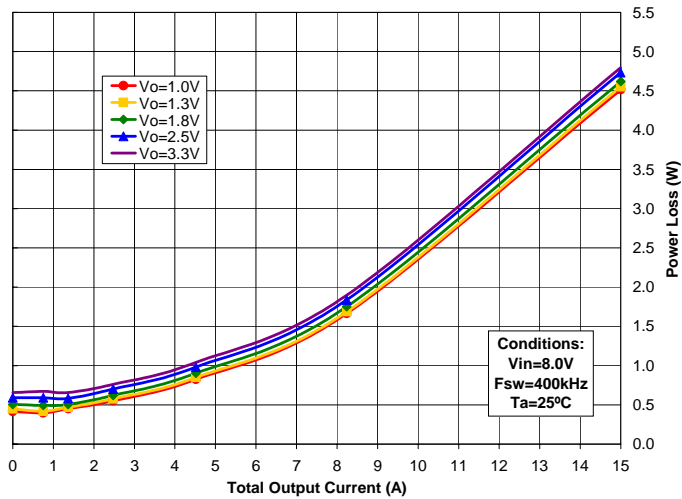
Output voltage: 1.0 – 3.3V

Switching Freq: 400kHz

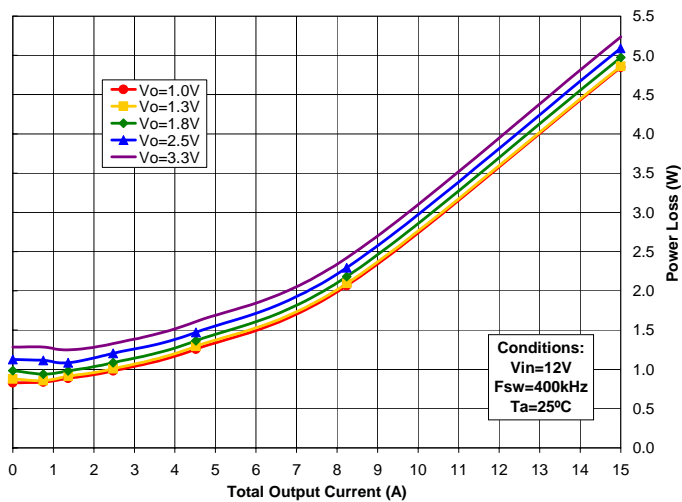
Output current: This reference design is capable of delivering a continuous current of 15A (with heatsink) or 12A (without heatsink) at an ambient temperature of 45°C and airflow of 300LFM.



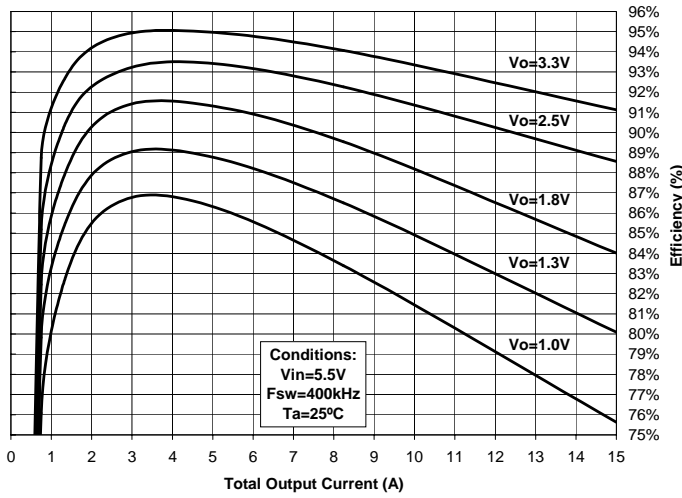
**Fig. 1: Power Loss vs. Output Current for Vin=5.5V**



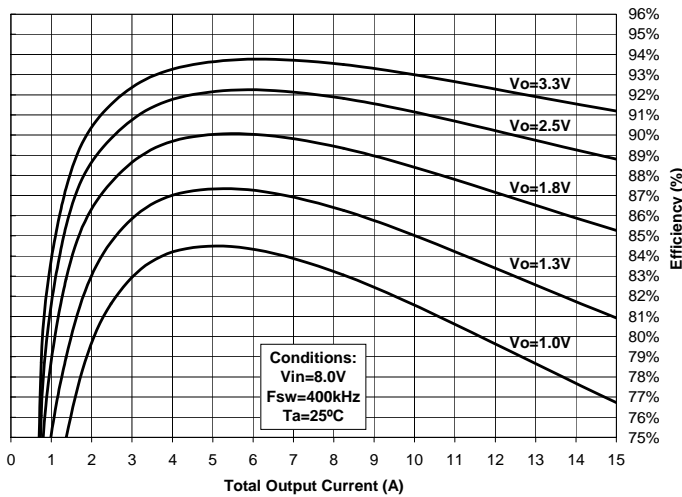
**Fig. 2: Power Loss vs. Output Current for Vin=8.0V**



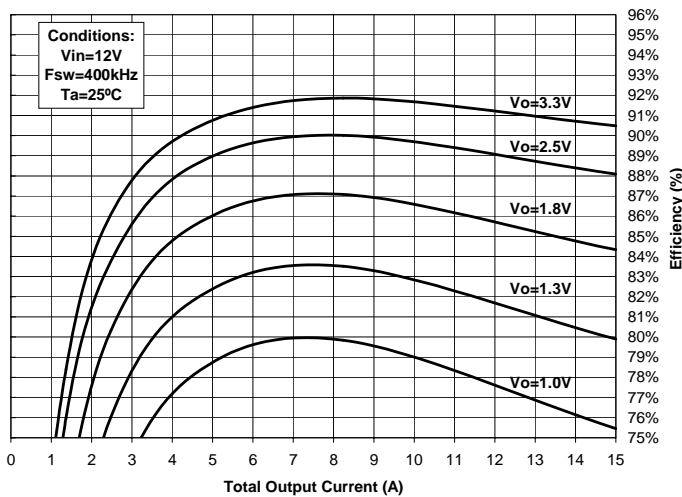
**Fig. 3: Power Loss vs. Output Current for Vin=12.0V**



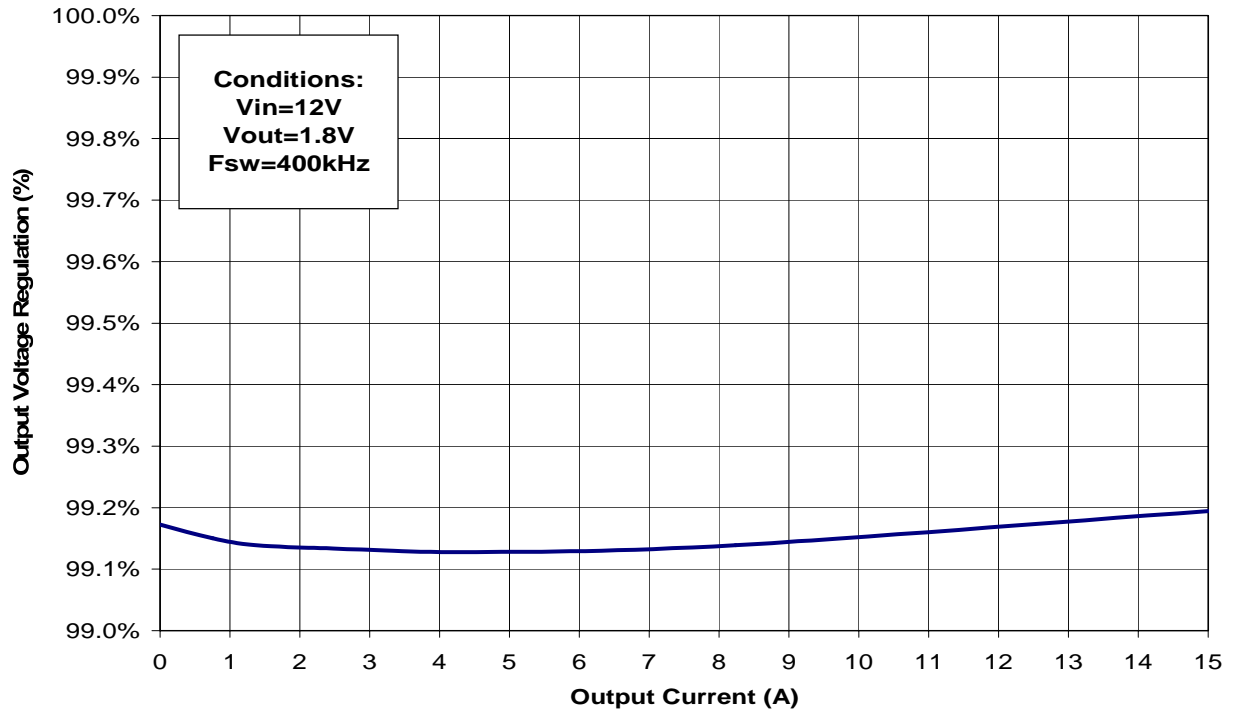
**Fig. 4: Efficiency vs. Output Current for Vin=5.5V**



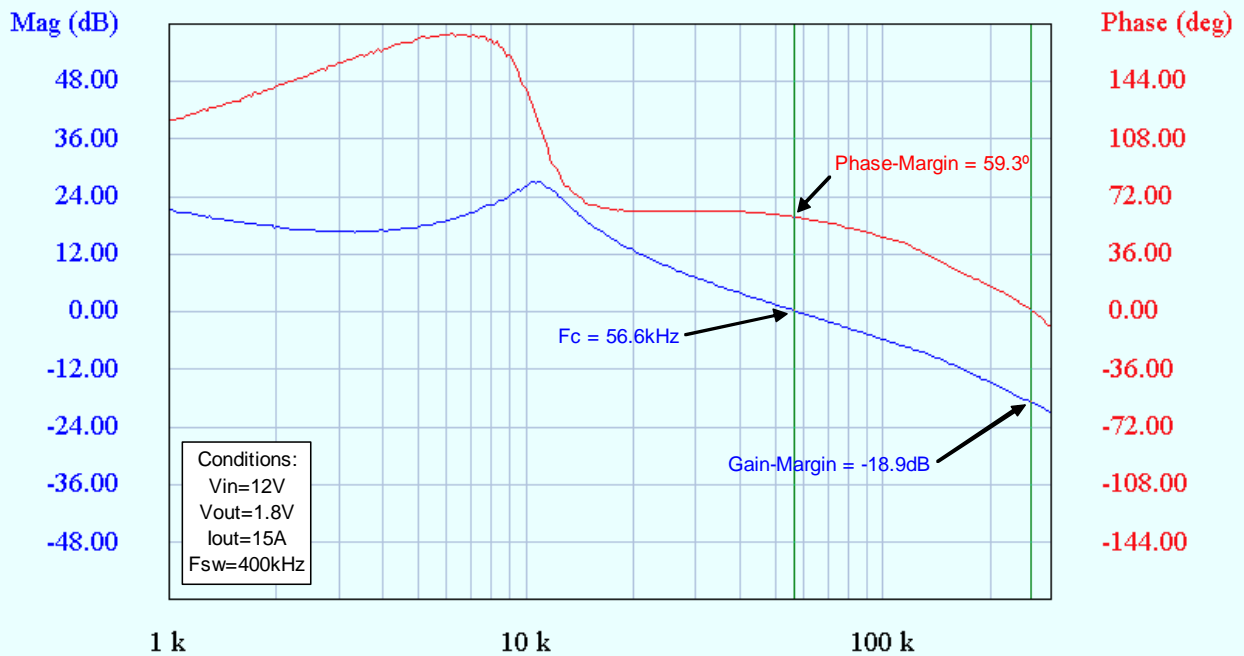
**Fig. 5: Efficiency vs. Output Current for Vin=8.0V**



**Fig. 6: Efficiency vs. Output Current for Vin=12.0V**



**Fig. 7: Output Voltage Regulation vs. Current**



**Fig. 8: Bode Plot**

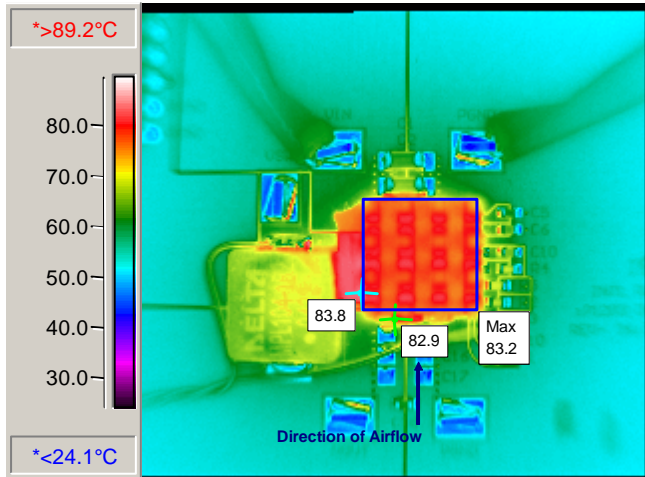


Fig. 9: Thermograph (With Heatsink)

**Conditions:**  
 **$V_{in} = 12V$**   
 **$V_{out} = 1.8V$**   
 **$I_{out} = 15A$**   
 **$F_{sw} = 400kHz$**   
**Ambient Temp. = 45°C**  
**Airflow = 300LFM**  
**Stabilizing Time = 15 min.**

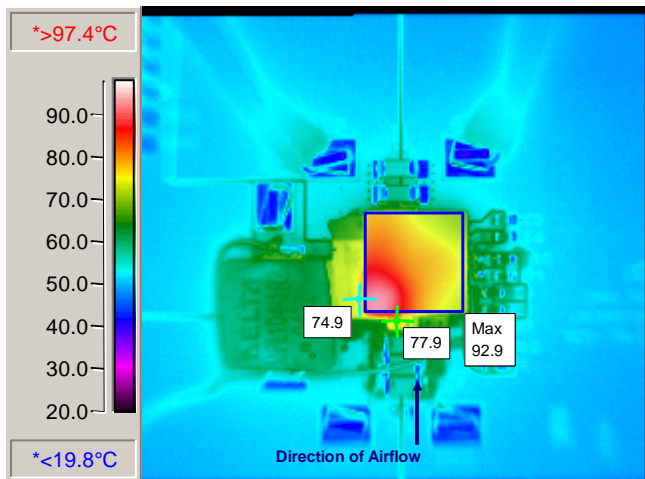


Fig. 10: Thermograph (No Heatsink)

**Conditions:**  
 **$V_{in} = 12V$**   
 **$V_{out} = 1.8V$**   
 **$I_{out} = 12A$**   
 **$F_{sw} = 400kHz$**   
**Ambient Temp. = 45°C**  
**Airflow = 300LFM**  
**Stabilizing Time = 15 min.**

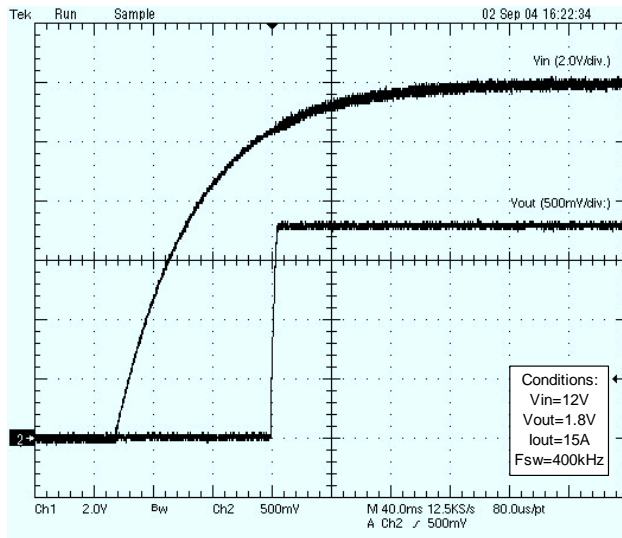


Fig. 11: Power Up Sequence

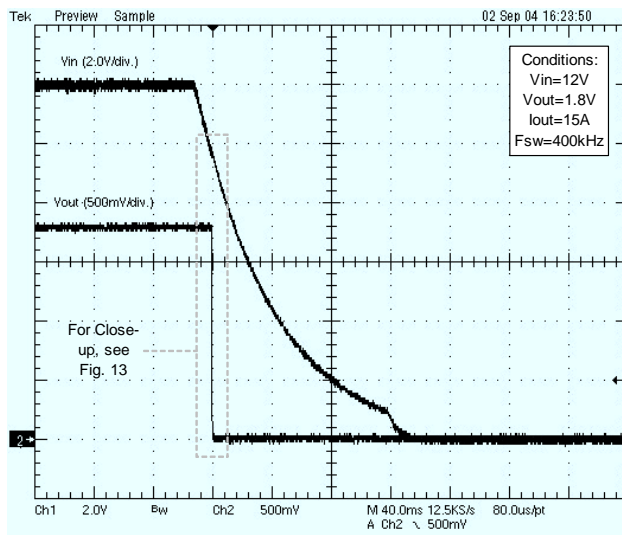


Fig. 12: Power Down Sequence

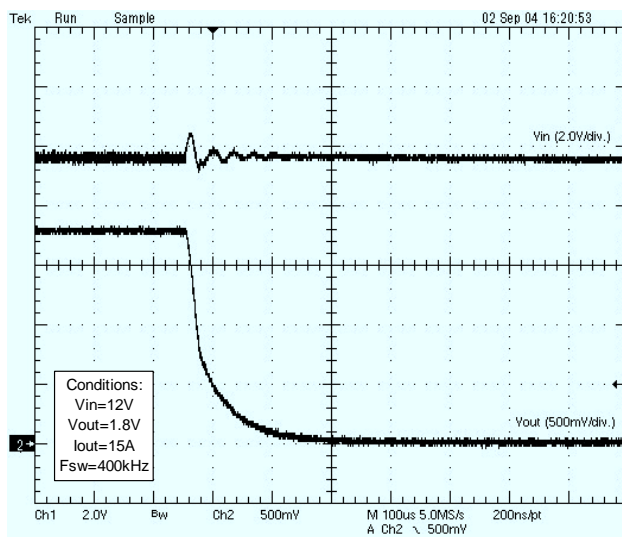
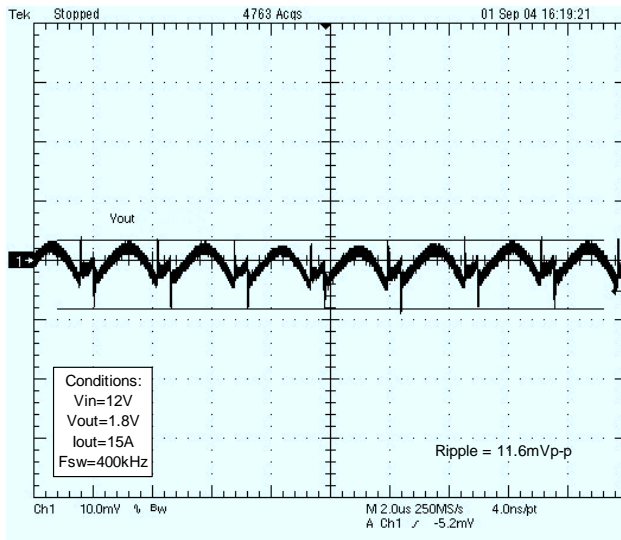
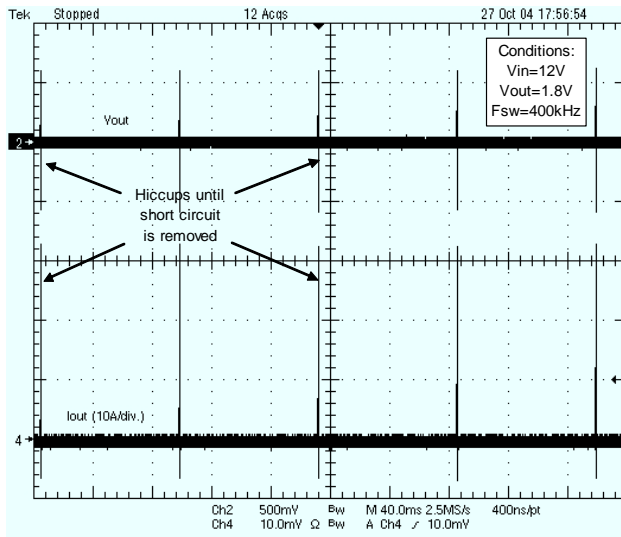


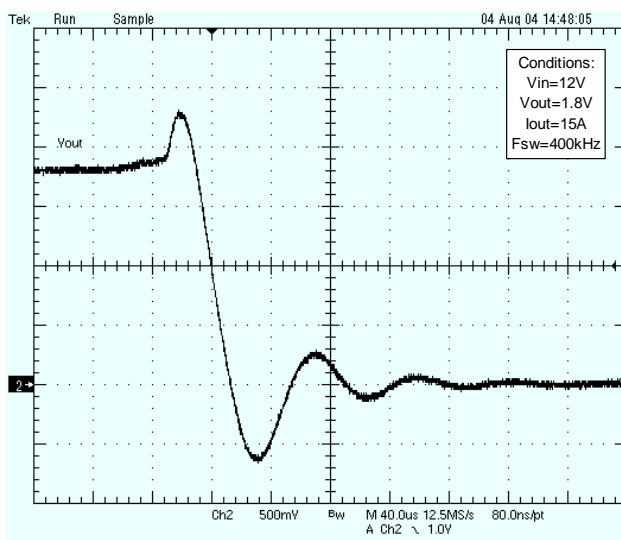
Fig. 13: Power Down – Close Up



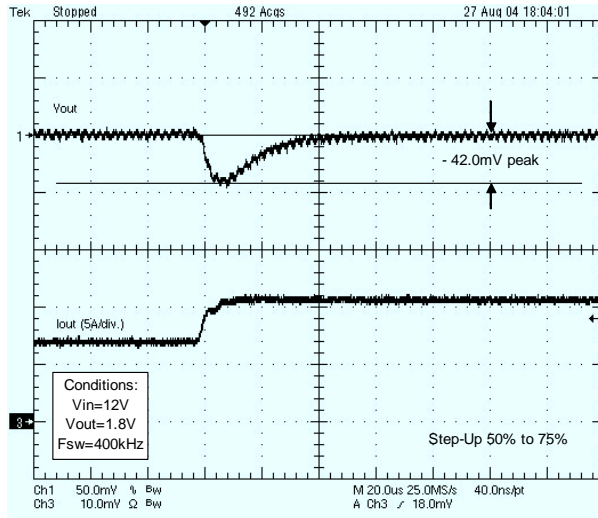
**Fig. 14: Output Voltage Ripple**



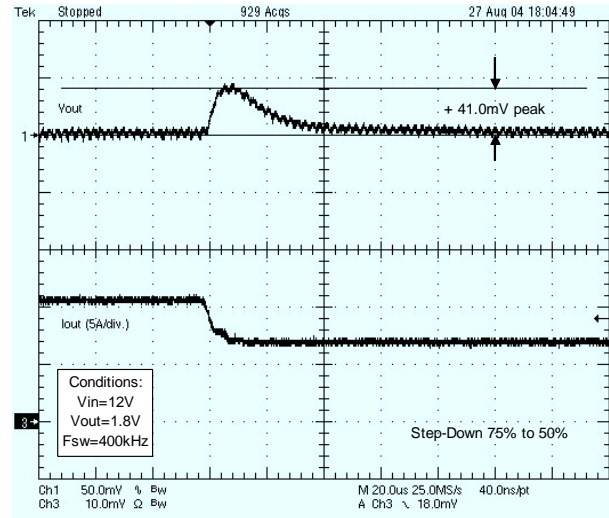
**Fig. 15: Short Circuit Protection**



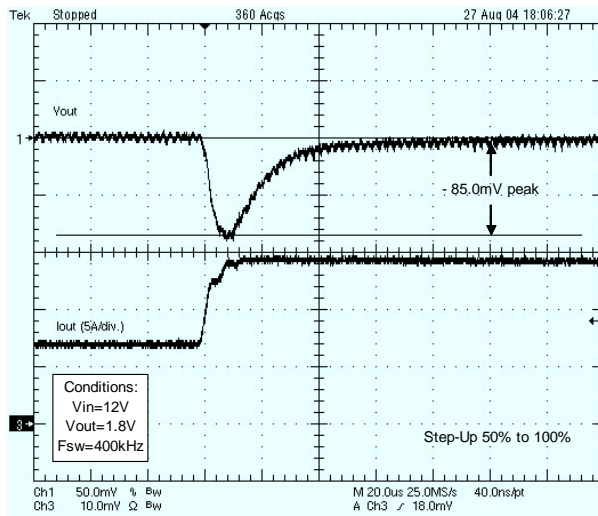
**Fig. 16: Over-voltage Protection**



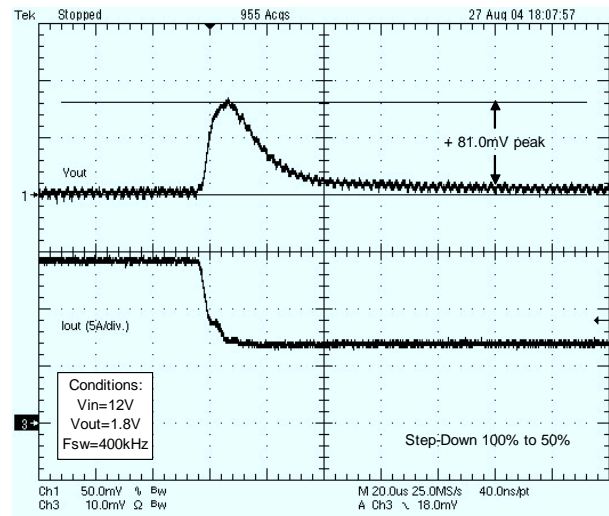
**Fig. 17: Iout Transient Step-Up 50% - 75%**



**Fig. 18: Iout Transient Step-Down 75% - 50%**



**Fig. 19: Iout Transient Step-Up 50% - 100%**



**Fig. 20: Iout Transient Step-Down 100% - 50%**



## Adjusting the Over-Current Limit

R9 is the resistor used to adjust the over-current trip point. The trip point corresponds to the peak inductor current indicated on the x-axis of Fig. 21. (Note: Fig. 21 is based on iP1203 T<sub>BLK</sub> = 125°C. The trip point will be higher than expected if the reference board is cool and is being used for short circuit testing.)

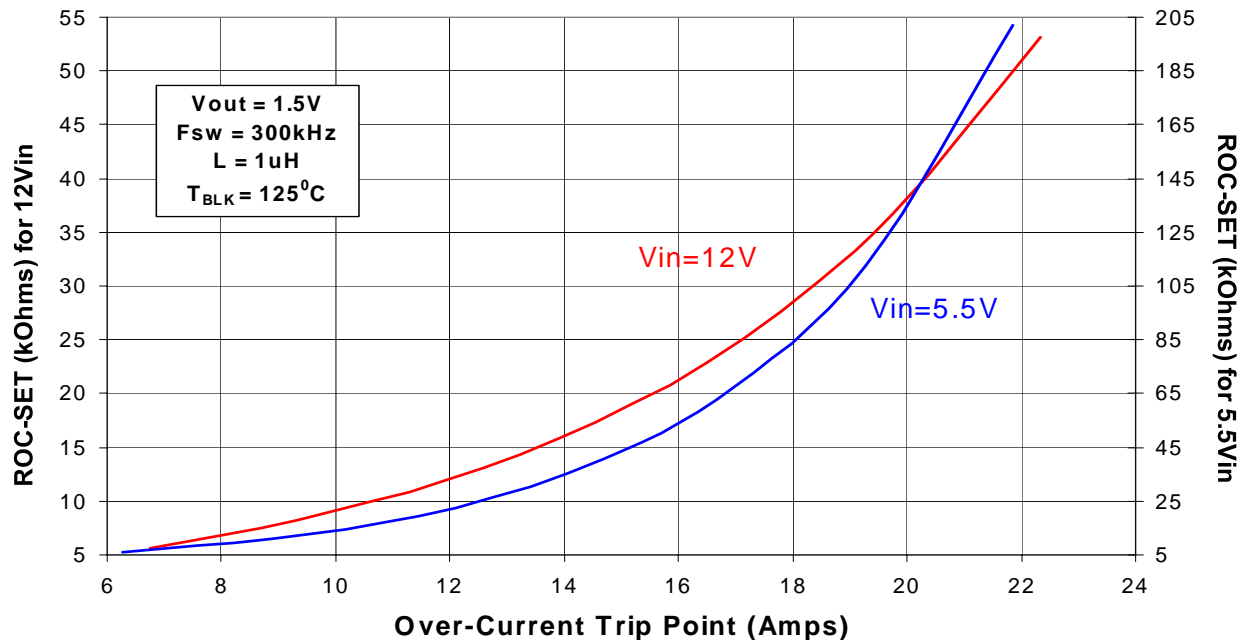


Fig. 21: ROCSET vs. Over-Current Trip Point

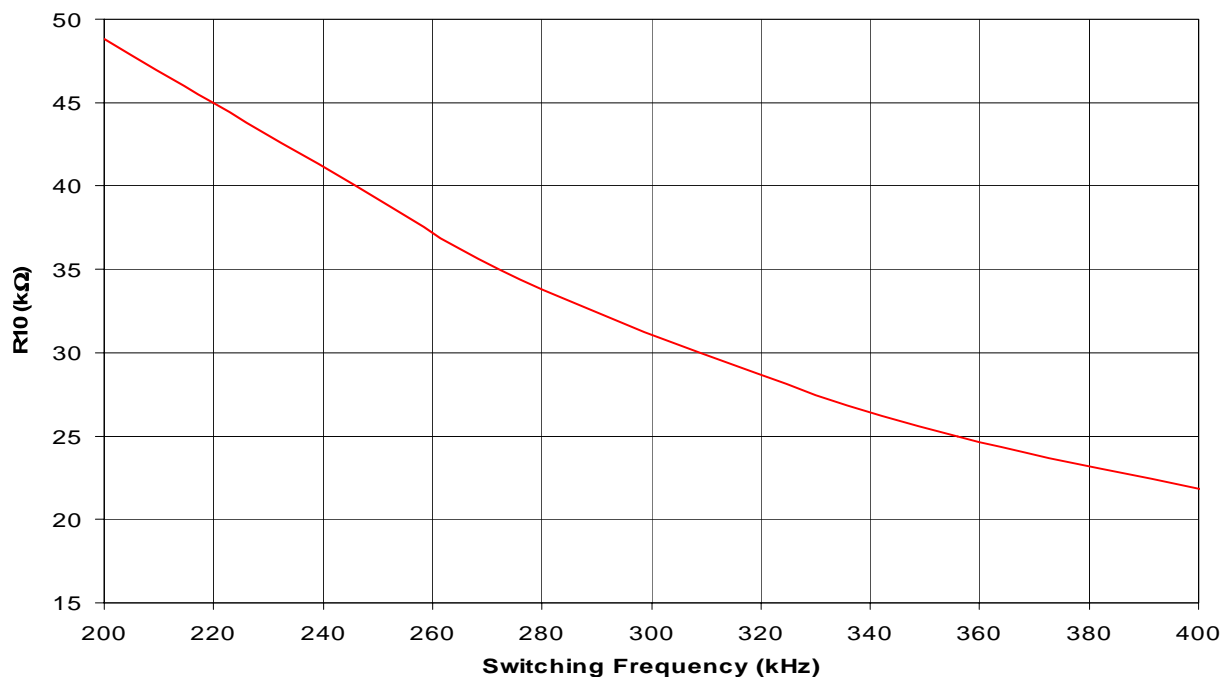


Fig. 22: R10 vs. Frequency

# IRDCiP1203-A

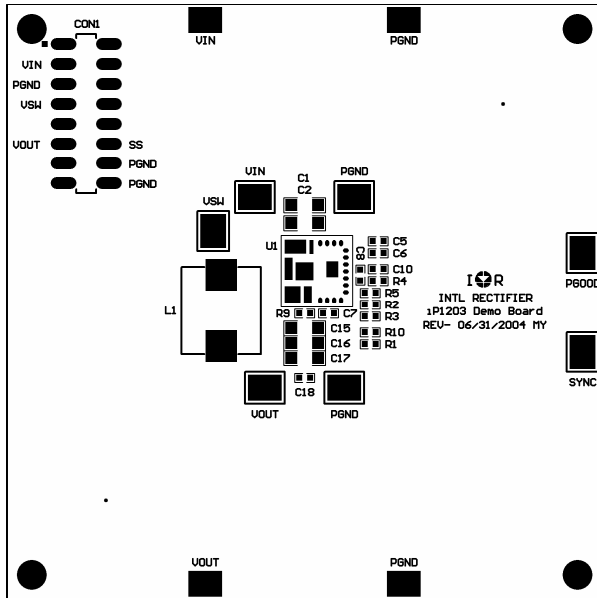


Fig. 23: Component Placement Top Layer

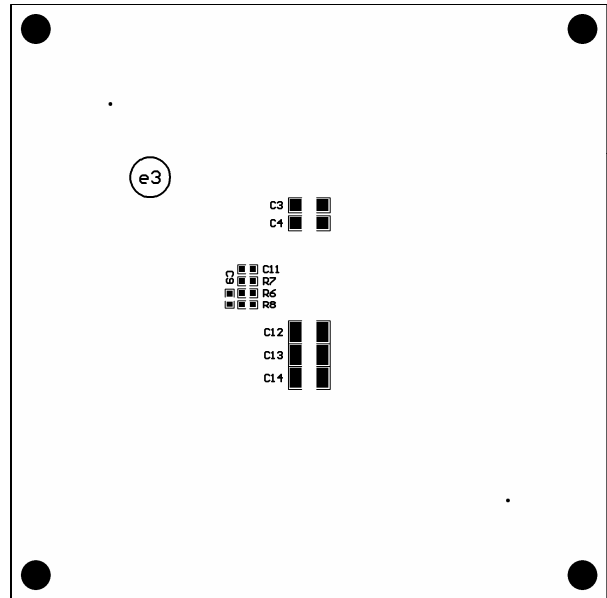


Fig. 24: Component Placement Bottom Layer

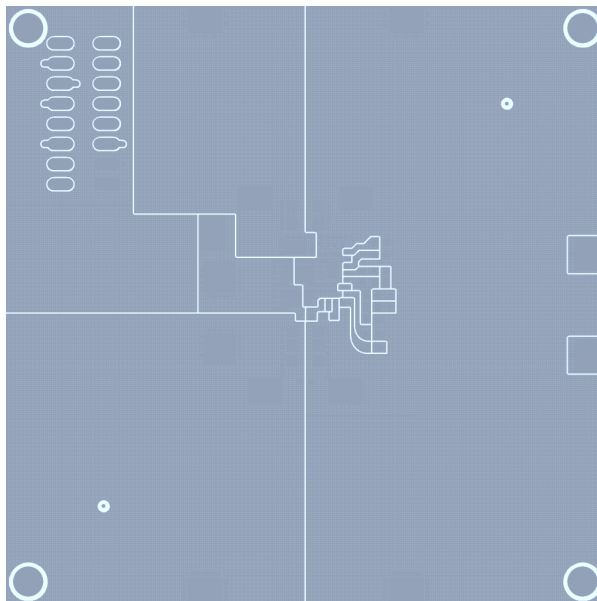


Fig. 25: Top Copper Layer

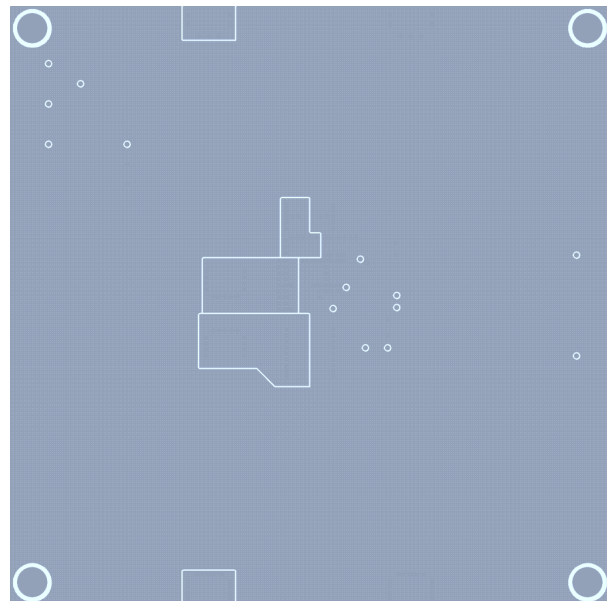
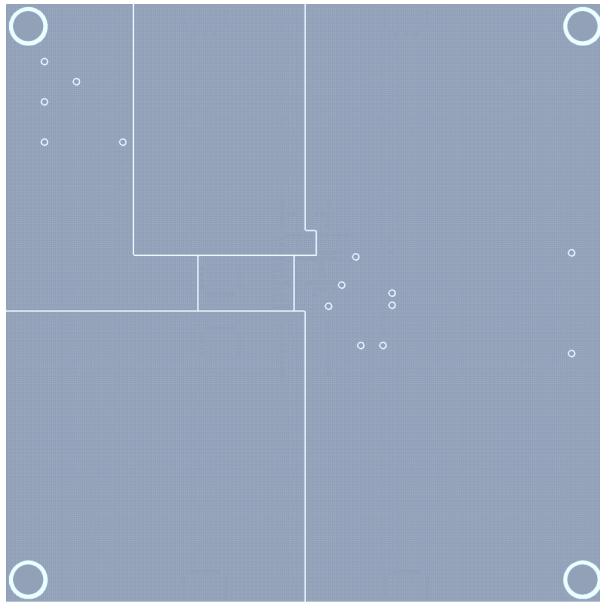
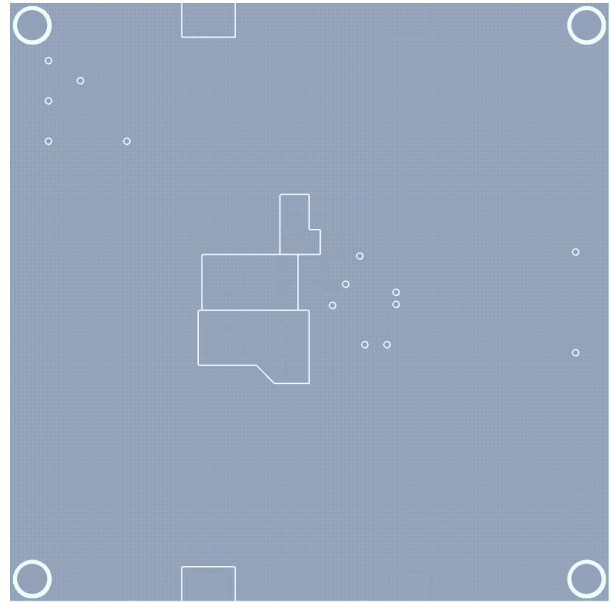


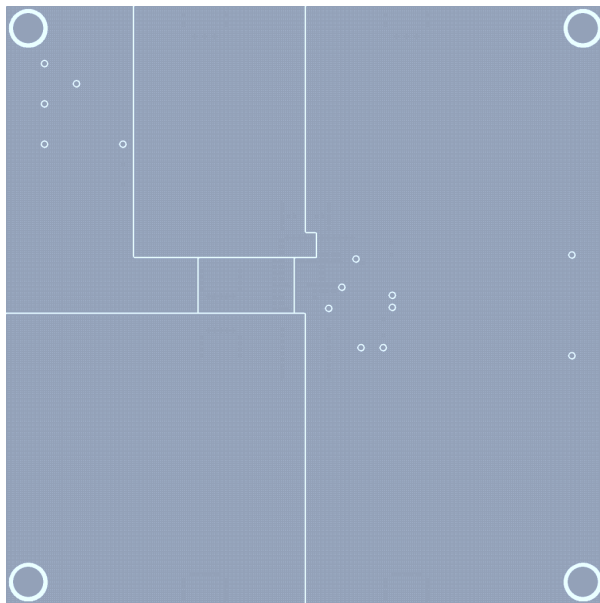
Fig. 26: 1<sup>st</sup> Mid Copper Layer



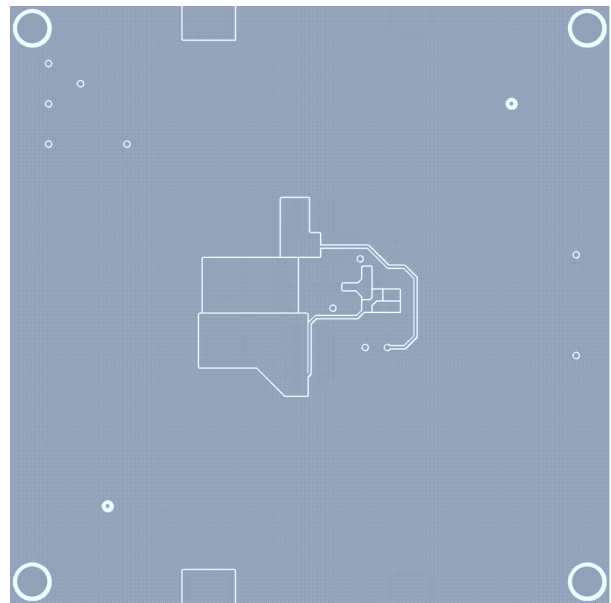
**Fig. 27: 2<sup>nd</sup> Mid Copper Layer**



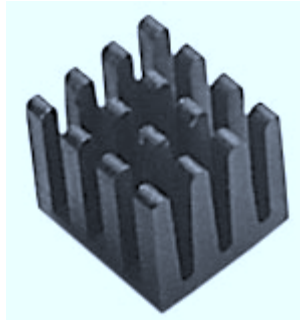
**Fig. 28: 3<sup>rd</sup> Mid Copper Layer**



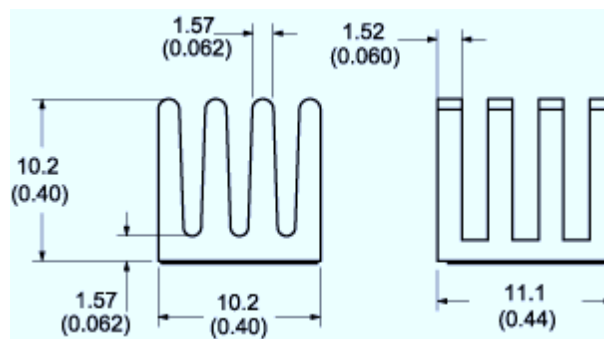
**Fig. 29: 4<sup>th</sup> Mid Copper Layer**



**Fig. 30: Bottom Copper Layer**

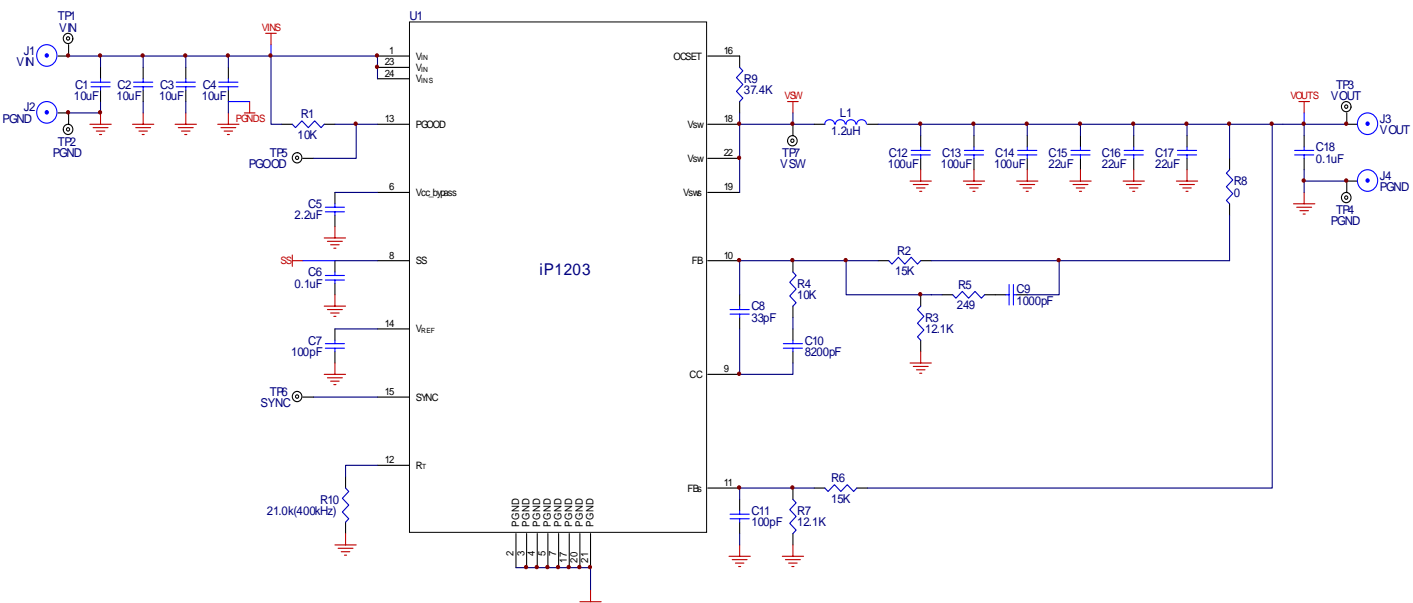


**Fig. 31: Heatsink Photo**



Tolerances are  $\pm 0.38$  ( $\pm 0.015$ )

**Fig. 32: Mechanical Outline Drawing of Heatsink**



**Fig. 33: Reference Design Schematic**

# IRDCiP1203-A



Quantity	Designator	Type 1	Type 2	Value 1	Value 2	Tolerance	Package	Manufacturer	Manufacturer P/N
4	C1, C2, C3, C4	capacitor	X7R	10.0uF	16V	10%	1206	TDK	C3216X7R1C106KT
1	C10	capacitor	X7R	8200pF	50V	10%	0603	KOA	X7R0603HTTD822K
2	C11, C7	capacitor	NPO	100pF	50V	5%	0603	Phycomp	0603CG101J9B20
3	C12, C13, C14	capacitor	X5R	100uF	6.3V	20%	1210	TDK	C3225X5R0J107M
3	C15, C16, C17	capacitor	X5R	22.0uF	6.3V	20%	1206	TDK	C3216X5R0J226M
2	C18, C6	capacitor	X7R	0.100uF	16V	10%	0603	MuRata	GRM188R71C104KA01D
1	C5	capacitor	X5R	2.20uF	6.3V	10%	0603	Murata	GRM39X5R225K6.3
1	C8	capacitor	NPO	33.0pF	50V	5%	0603	KOA	NPO0603HTTD330J
1	C9	capacitor	COG	1000pF	100V	5%	0603	TDK	C1608COG2A102J
1	H1	hardware	heatsink	16 fins	0.400"	-	10.6mm x 10.6mm	Aavid/ Thermalloy	NP974686 REV 1
1	L1	inductor	metal composite	1.20uH	22A	20%	SMT	Delta Electronics	MPL104-1R21R
2	R1, R4	resistor	thick film	10.0K	1/10W	1%	0603	KOA	RK73H1J1002F
1	R10	resistor	thick film	21.0K	1/10W	1%	0603	KOA	RK73H1JLTD2102F
2	R2, R6	resistor	thick film	15.0K	1/10W	1%	0603	KOA	RK73H1J1502F
2	R3, R7	resistor	thick film	12.1K	1/10W	1%	0603	KOA	RK73H1JLTD1212F
1	R5	resistor	thick film	249	1/10W	1%	0603	KOA	RK73H1JLTD2490F
1	R8	resistor	carbon film	0	1/16W	<50m	0603	ROHM	MCR03EZHJ000
1	R9	resistor	thick film	37.4K	1/10W	1%	0603	KOA	RK73H1J3742F
7	PGND, PGND, PGOOD, SYNC, VIN, VOUT, VSW	hardware	test point	90 mils	112 x 150 mils	-	SMT	Keystone	5016
1	U1	iP1203	LGA unit	-	-	-	9mm x 9mm	IRF	-

**Table 1: Reference Design Bill of Materials**

Refer to the following application notes for detailed guidelines and suggestions when implementing iPOWIR Technology products:

**AN-1028: Recommended Design, Integration and Rework Guidelines for International Rectifier's iPowIR Technology BGA and LGA and Packages**

This paper discusses optimization of the layout design for mounting iPowIR BGA and LGA packages on printed circuit boards, accounting for thermal and electrical performance and assembly considerations. Topics discussed includes PCB layout placement, and via interconnect suggestions, as well as soldering, pick and place, reflow, inspection, cleaning and reworking recommendations.

**AN-1030: Applying iPOWIR Products in Your Thermal Environment**

This paper explains how to use the Power Loss and SOA curves in the data sheet to validate if the operating conditions and thermal environment are within the Safe Operating Area of the iPOWIR product.

**AN-1047: Graphical solution for two branch heatsinking Safe Operating Area**

Detailed explanation of the dual axis SOA graph and how it is derived.

*Use of this design for any application should be fully verified by the customer. International Rectifier cannot guarantee suitability for your applications, and is not liable for any result of usage for such applications including, without limitation, personal or property damage or violation of third party intellectual property rights.*

**IR WORLD HEADQUARTERS:** 233 Kansas St., El Segundo, California 90245, USA Tel: (310) 252-7105  
TAC Fax: (310) 252-7903