

General Description

The AOD7N65 & AOI7N65 have been fabricated using an advanced high voltage MOSFET process that is designed to deliver high levels of performance and robustness in popular AC-DC applications. By providing low $R_{DS(on)}$, C_{iss} and C_{rss} along with guaranteed avalanche capability these parts can be adopted quickly into new and existing offline power supply designs.

Product Summary

| | |
|---------------------------------|------------|
| V_{DS} | 750V@150°C |
| I_D (at $V_{GS}=10V$) | 7A |
| $R_{DS(ON)}$ (at $V_{GS}=10V$) | < 1.56Ω |

100% UIS Tested!
 100% R_g Tested!

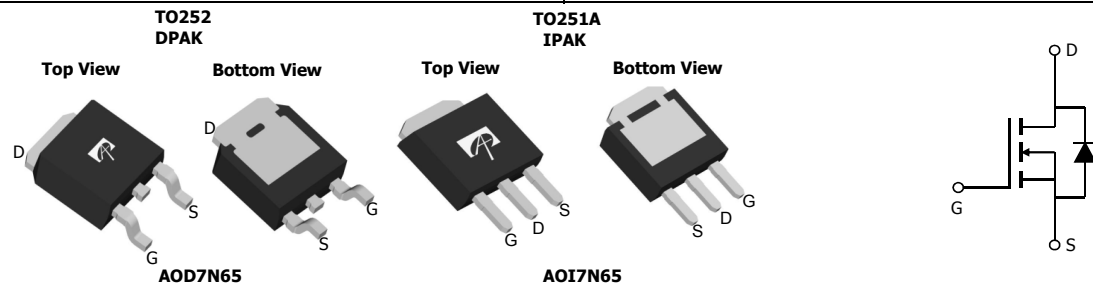
Absolute Maximum Ratings $T_A=25^\circ C$ unless otherwise noted

| Parameter | Symbol | Maximum | Units |
|--|----------------|-------------------|-------|
| Drain-Source Voltage | V_{DS} | 650 | V |
| Gate-Source Voltage | V_{GS} | ±30 | V |
| Continuous Drain Current ^B | I_D | $T_C=25^\circ C$ | 7 |
| | | $T_C=100^\circ C$ | 4.3 |
| Pulsed Drain Current ^C | I_{DM} | 23 | A |
| Avalanche Current ^C | I_{AR} | 3.1 | A |
| Repetitive avalanche energy ^C | E_{AR} | 144 | mJ |
| Single pulsed avalanche energy ^H | E_{AS} | 288 | mJ |
| Peak diode recovery dv/dt | dv/dt | 5 | V/ns |
| Power Dissipation ^B | P_D | $T_C=25^\circ C$ | 178 |
| | | Derate above 25°C | 1.4 |
| Junction and Storage Temperature Range | T_J, T_{STG} | -50 to 150 | °C |
| Maximum lead temperature for soldering purpose, 1/8" from case for 5 seconds | T_L | 300 | °C |

Thermal Characteristics

| Parameter | Symbol | Typical | Maximum | Units |
|--|-----------------|---------|---------|-------|
| Maximum Junction-to-Ambient ^{A,G} | $R_{\theta JA}$ | 45 | 55 | °C/W |
| Maximum Case-to-sink ^A | $R_{\theta CS}$ | - | 0.5 | °C/W |
| Maximum Junction-to-Case ^{D,F} | $R_{\theta JC}$ | 0.5 | 0.7 | °C/W |

Electrical Characteristics (T_J=25°C unless otherwise noted)

| Symbol | Parameter | Conditions | Min | Typ | Max | Units |
|------------------------------------|---|---|--|------|------|-------|
| STATIC PARAMETERS | | | | | | |
| BV _{DSS} | Drain-Source Breakdown Voltage | I _D =250μA, V _{GS} =0V, T _J =25°C | 650 | | | V |
| | | I _D =250μA, V _{GS} =0V, T _J =150°C | | 750 | | |
| BV _{DSS} /ΔT _J | Breakdown Voltage Temperature Coefficient | I _D =250μA, V _{GS} =0V | | 0.67 | | V/°C |
| I _{DSS} | Zero Gate Voltage Drain Current | V _{DS} =650V, V _{GS} =0V | | | 1 | μA |
| | | V _{DS} =520V, T _J =125°C | | | 10 | |
| I _{GSS} | Gate-Body leakage current | V _{DS} =0V, V _{GS} =±30V | | | ±100 | nA |
| V _{GS(th)} | Gate Threshold Voltage | V _{DS} =5V, I _D =250μA | 3.3 | 3.9 | 4.5 | V |
| R _{DS(ON)} | Static Drain-Source On-Resistance | V _{GS} =10V, I _D =3.5A | | 1.2 | 1.56 | Ω |
| g _{FS} | Forward Transconductance | V _{DS} =40V, I _D =3.5A | | 7 | | S |
| V _{SD} | Diode Forward Voltage | I _S =1A, V _{GS} =0V | | 0.72 | 1 | V |
| I _S | Maximum Body-Diode Continuous Current | | | | 7 | A |
| I _{SM} | Maximum Body-Diode Pulsed Current | | | | 23 | A |
| DYNAMIC PARAMETERS | | | | | | |
| C _{iss} | Input Capacitance | V _{GS} =0V, V _{DS} =25V, f=1MHz | 780 | 982 | 1180 | pF |
| C _{oss} | Output Capacitance | | 60 | 86 | 115 | pF |
| C _{rss} | Reverse Transfer Capacitance | | 4 | 7 | 10 | pF |
| R _g | Gate resistance | V _{GS} =0V, V _{DS} =0V, f=1MHz | 1.5 | 3.2 | 5 | Ω |
| SWITCHING PARAMETERS | | | | | | |
| Q _g | Total Gate Charge | V _{GS} =10V, V _{DS} =520V, I _D =7A | 15 | 19.6 | 24 | nC |
| Q _{gs} | Gate Source Charge | | 4.6 | | | nC |
| Q _{gd} | Gate Drain Charge | | 8.2 | | | nC |
| t _{D(on)} | Turn-On Delay Time | V _{GS} =10V, V _{DS} =325V, I _D =7A, R _G =25Ω | | 26 | | ns |
| t _r | Turn-On Rise Time | | 43 | | | ns |
| t _{D(off)} | Turn-Off Delay Time | | 53 | | | ns |
| t _f | Turn-Off Fall Time | | 32 | | | ns |
| t _{rr} | Body Diode Reverse Recovery Time | | I _F =7A, dI/dt=100A/μs, V _{DS} =100V | 290 | 365 | 440 |
| Q _{rr} | Body Diode Reverse Recovery Charge | I _F =7A, dI/dt=100A/μs, V _{DS} =100V | 3.4 | 4.3 | 5.4 | μC |

A. The value of R_{θJA} is measured with the device in a still air environment with T_A=25°C.

B. The power dissipation P_D is based on T_{J(MAX)}=150°C in a TO252 package, using junction-to-case thermal resistance, and is more useful in setting the upper dissipation limit for cases where additional heatsinking is used.

C. Repetitive rating, pulse width limited by junction temperature T_{J(MAX)}=150°C.

D. The R_{θJA} is the sum of the thermal impedance from junction to case R_{θJC} and case to ambient.

E. The static characteristics in Figures 1 to 6 are obtained using <300 μs pulses, duty cycle 0.5% max.

F. These curves are based on the junction-to-case thermal impedance which is measured with the device mounted to a large heatsink, assuming a maximum junction temperature of T_{J(MAX)}=150°C.

G. These tests are performed with the device mounted on 1 in² FR-4 board with 2oz. Copper, in a still air environment with T_A=25°C.

H. L=60mH, I_{AS}=3.1A, V_{DD}=150V, R_G=10Ω, Starting T_J=25°C

THIS PRODUCT HAS BEEN DESIGNED AND QUALIFIED FOR THE CONSUMER MARKET. APPLICATIONS OR USES AS CRITICAL COMPONENTS IN LIFE SUPPORT DEVICES OR SYSTEMS ARE NOT AUTHORIZED. AOS DOES NOT ASSUME ANY LIABILITY ARISING OUT OF SUCH APPLICATIONS OR USES OF ITS PRODUCTS. AOS RESERVES THE RIGHT TO IMPROVE PRODUCT DESIGN, FUNCTIONS AND RELIABILITY WITHOUT NOTICE.

TYPICAL ELECTRICAL AND THERMAL CHARACTERISTICS

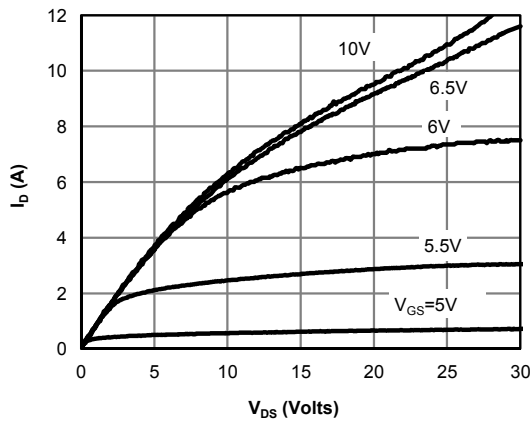

Fig 1: On-Region Characteristics

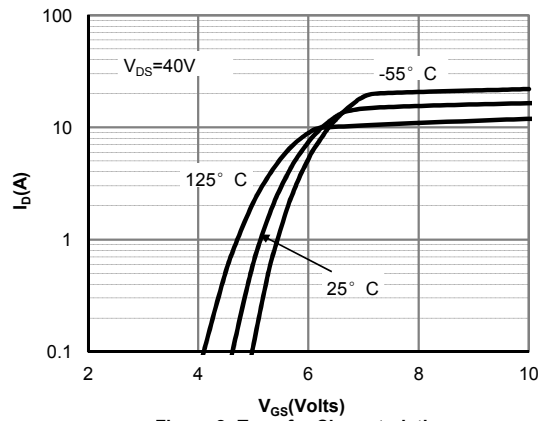

Figure 2: Transfer Characteristics

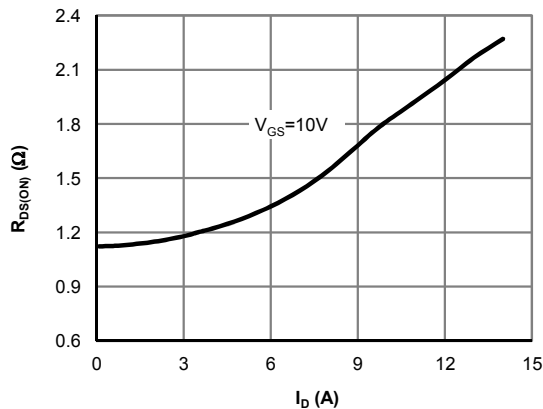

Figure 3: On-Resistance vs. Drain Current and Gate Voltage

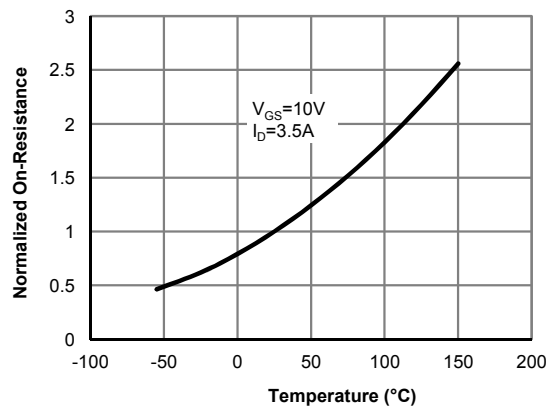

Figure 4: On-Resistance vs. Junction Temperature

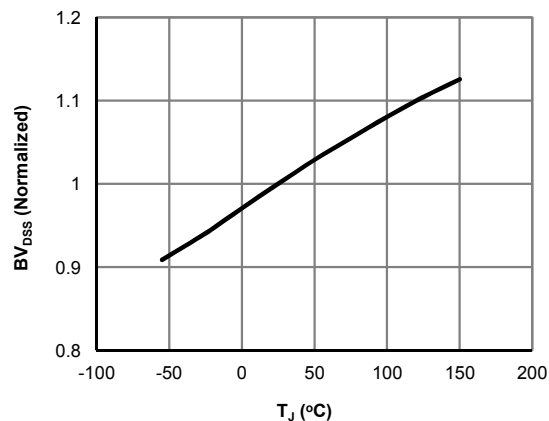

Figure 5: Break Down vs. Junction Temperature

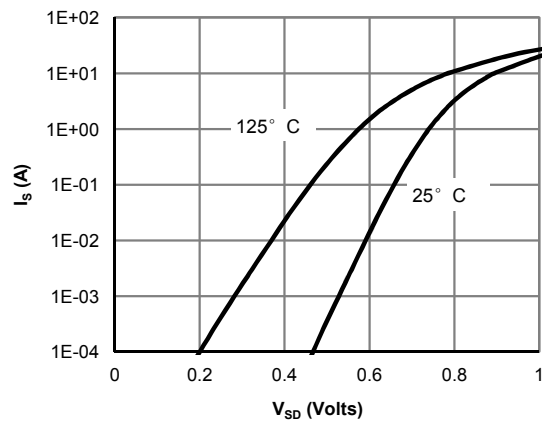

Figure 6: Body-Diode Characteristics

TYPICAL ELECTRICAL AND THERMAL CHARACTERISTICS

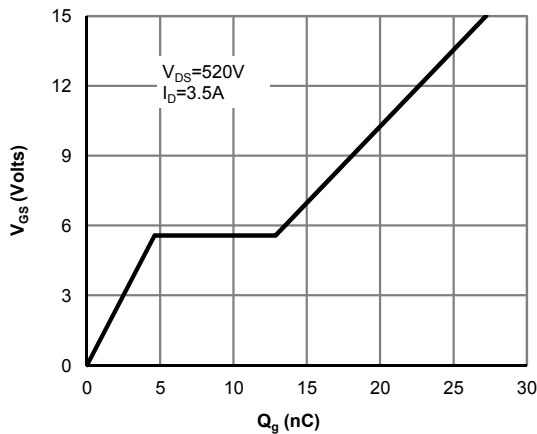

Figure 7: Gate-Charge Characteristics

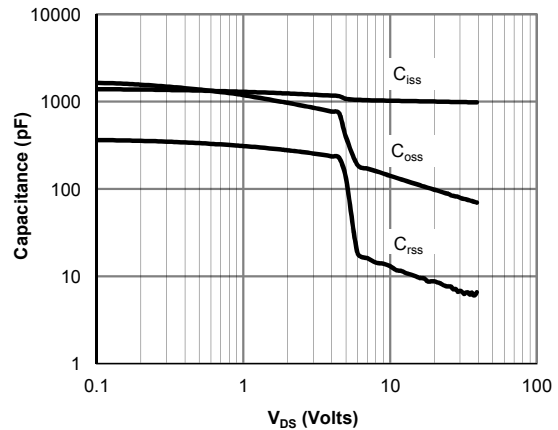

Figure 8: Capacitance Characteristics

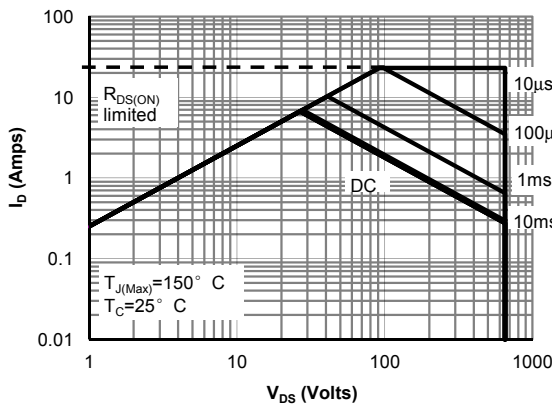

Figure 9: Maximum Forward Biased Safe Operating Area (Note F)

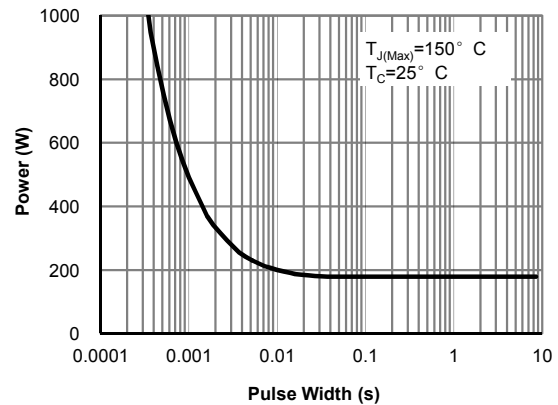

Figure 10: Single Pulse Power Rating Junction-to-Case (Note F)

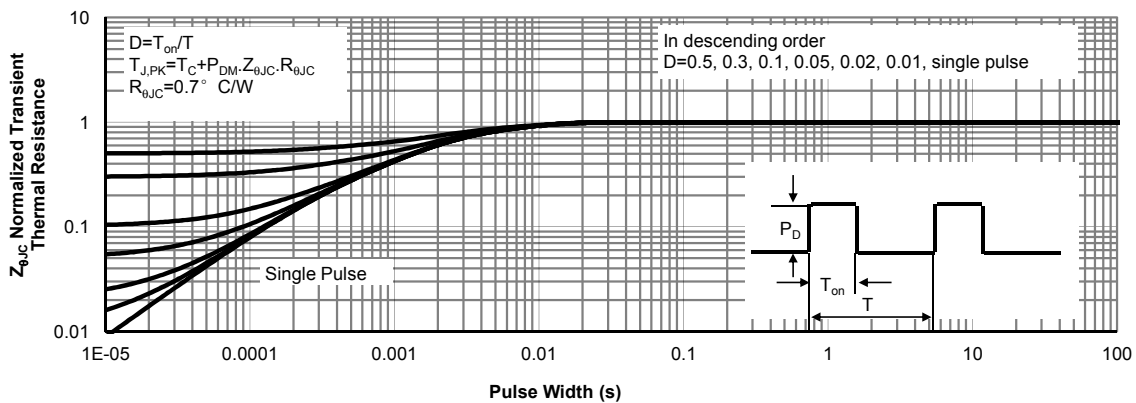

Figure 11: Normalized Maximum Transient Thermal Impedance (Note F)

TYPICAL ELECTRICAL AND THERMAL CHARACTERISTICS

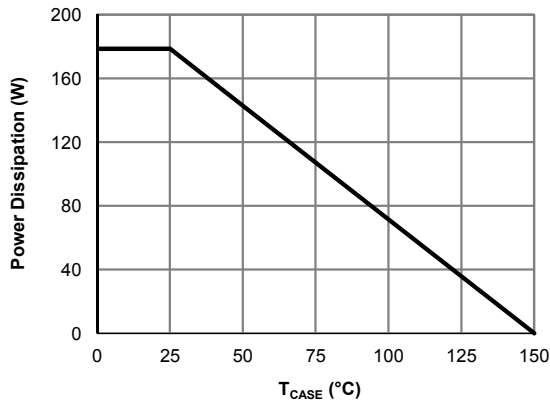

Figure 12: Power De-rating (Note B)

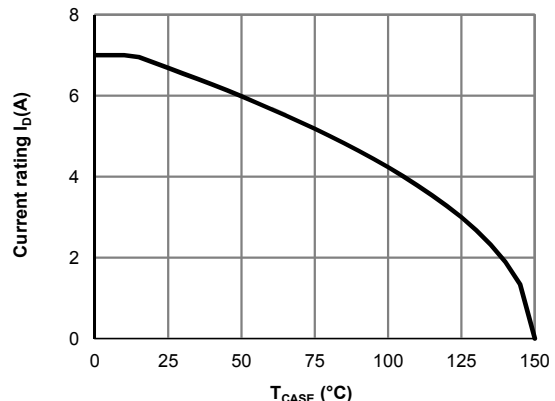

Figure 13: Current De-rating (Note B)

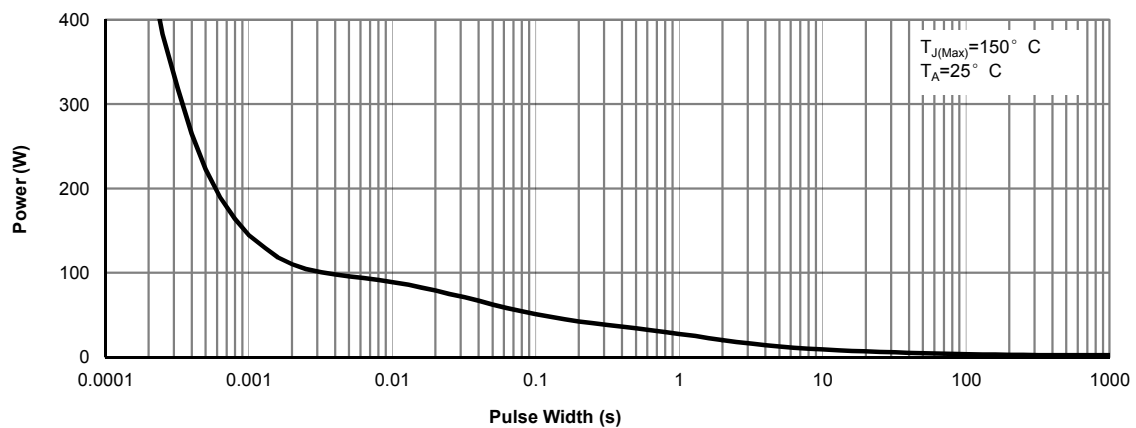

Figure 14: Single Pulse Power Rating Junction-to-Ambient (Note G)

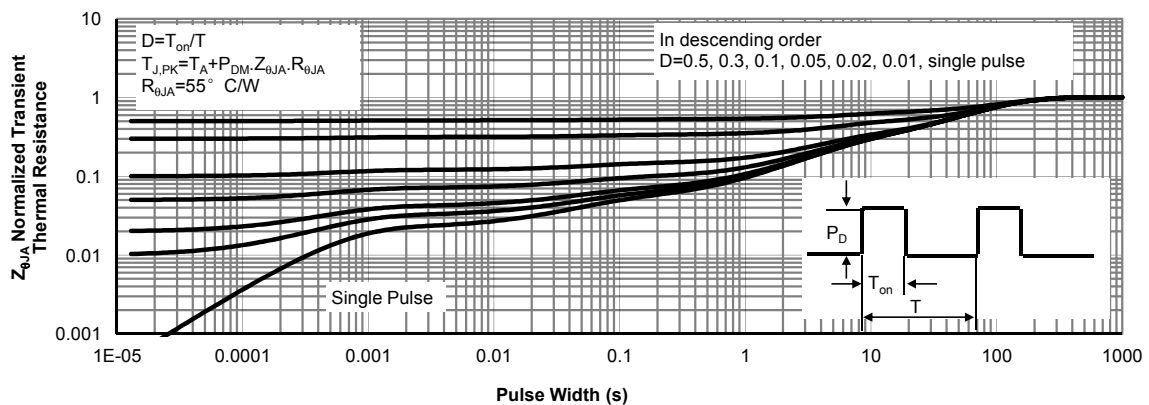
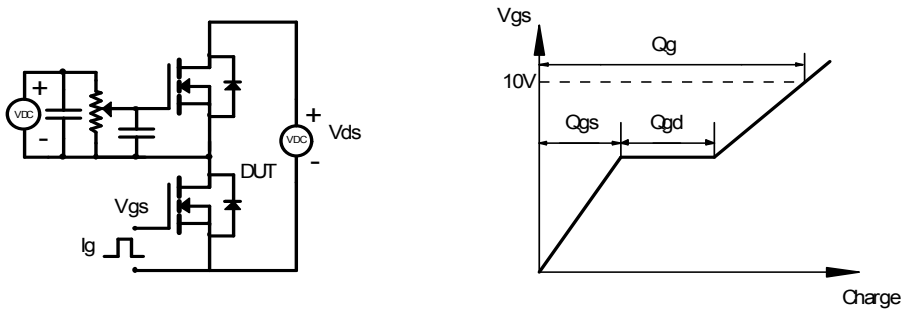
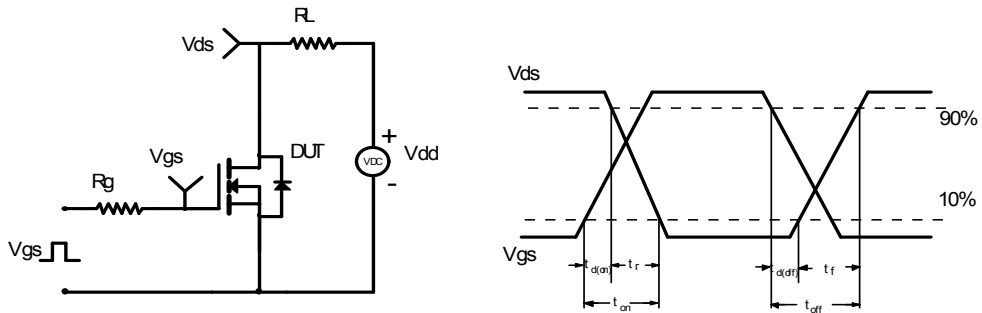

Figure 15: Normalized Maximum Transient Thermal Impedance (Note G)

Gate Charge Test Circuit & Waveform



Resistive Switching Test Circuit & Waveforms



Unclamped Inductive Switching (UIS) Test Circuit & Waveforms

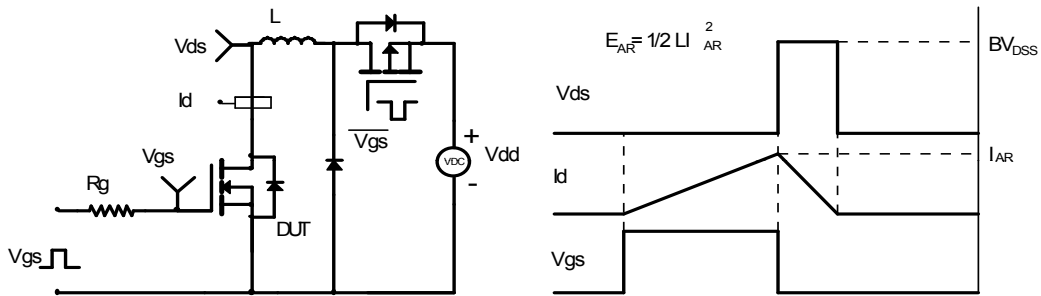

Diode Recovery Test Circuit & Waveforms

